

# OPERATING INSTRUCTIONS

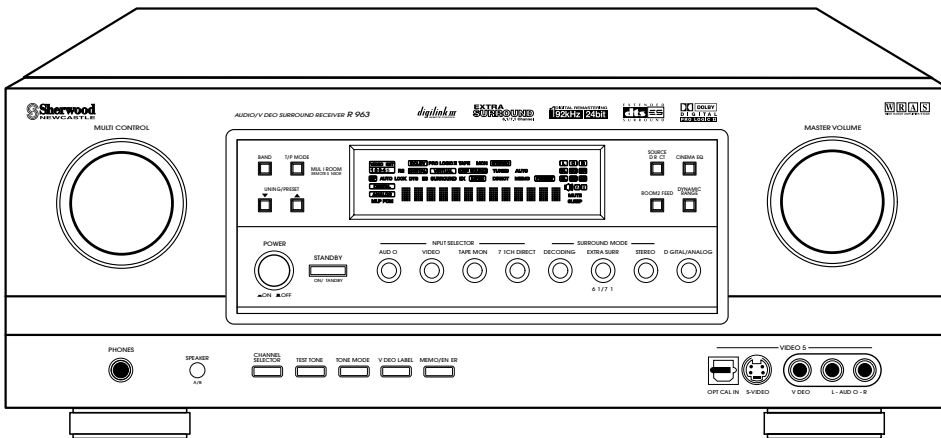

## R-963

### AUDIO/VIDEO SURROUND RECEIVER



# Introduction

## UNPACKING AND INSTALLATION

### Congratulations on Your Purchase!

Your new high fidelity receiver is designed to deliver maximum enjoyment and years of trouble free service. Please take a few moments to read this manual thoroughly. It will explain the features and operation of your unit and help ensure a trouble free installation. Please unpack your unit carefully. We recommend that you save the carton and packing material. They will be helpful if you ever need to move your unit and may be required if you ever need to return it for service. Your unit is designed to be placed in a horizontal position and it is important to allow at least two inches of space behind your unit for adequate ventilation and cabling convenience.

To avoid damage, never place the unit near radiators, in front of heating vents, in direct sunlight, or in excessively humid or dusty locations. Connect your complementary components as illustrated in the following section.

	<b>CAUTION</b> RISK OF ELECTRIC SHOCK DO NOT OPEN	
<b>CAUTION : TO REDUCE THE RISK OF ELECTRIC SHOCK, DO NOT REMOVE COVER (OR BACK). NO USER-SERVICEABLE PARTS INSIDE. REFER SERVICING TO QUALIFIED SERVICE PERSONNEL.</b>		



This symbol is intended to alert the user to the presence of uninsulated "dangerous voltage" within the product's enclosure that may be of sufficient magnitude to constitute a risk of electric shock to persons.



This symbol is intended to alert the user to the presence of important operating and maintenance (servicing) instructions in the literature accompanying the appliance.

### WARNING

To reduce the risk of fire or electric shock, do not expose this appliance to rain or moisture.

**Caution : Do not block ventilation openings or stack other equipment on the top.**

### FOR U.S.A

■ **Note to CATV System Installer:** This reminder is provided to call the CATV system installer's attention to Article 820-40 of the NEC that provides guidelines for proper grounding and, in particular, specifies that the cable ground shall be connected to the grounding system of the building, as close to the point of cable entry as practical.

### FCC INFORMATION

This equipment has been tested and found to comply with the limits for a Class B digital device, pursuant to Part 15 of the FCC Rules. These limits are designed to provide reasonable protection against harmful interference in a residential installation. This equipment generates, uses and can radiate radio frequency energy and, if not installed and used in accordance with the instructions, may cause harmful interference to radio communications. However, there is no guarantee that interference will not occur in a particular installation. If this equipment does cause harmful interference to radio or television reception, which can be determined by turning the equipment off and on, the user is encouraged to try to correct the interference by one or more of the following measures:

- Reorient or relocate the receiving antenna.
- Increase the separation between the equipment and receiver.
- Connect the equipment into an outlet on a circuit different from that to which the receiver is connected.
- Consult the dealer or an experienced radio/TV technician for help.

**CAUTION :** Any changes or modifications in construction of this device which are not expressly approved by the party responsible for compliance could void the user's authority to operate the equipment.

### Caution regarding placement (Except for U.S.A and Canada)

To maintain proper ventilation, be sure to leave a space around the unit (from the largest outer dimensions including projections) equal to, or greater than, shown below.



- Left and right panels: 5 cm
- Rear panel: 10 cm
- Top panel: 20 cm

**READ THIS BEFORE OPERATING YOUR UNIT**

**FOR U.S.A AND CANADA** ..... 120 V

**FOR YOUR SAFETY**

Units shipped to the U.S.A and Canada are designed for operation on 120 Volts AC only.

Observe all safety precautions for use of a polarized AC plug. However, some products may be supplied with a non polarized plug.

**CAUTION:** To prevent electric shock, match wide blade of plug to wide slot, insert fully.

**FOR EUROPE AND AUSTRALIA** .....230 V/240 V

**FOR YOUR SAFETY**

Units shipped to Australia are designed for operation on 240 V AC only.

To ensure safe operation, the three-pin plug supplied must be inserted only into a standard three-pin power point which is effectively earthed through the normal household wiring. Extension cords used with the equipment must be three-core and be correctly wired to provide connection to earth.

Improper extension cords are a major cause of fatalities. The fact that the equipment operates satisfactorily does not imply that the power point is earthed and that the installation is completely safe. For your safety, if in any doubt about the effective earthing of the power point, consult a qualified electrician.

**PAN-EUROPEAN UNIFIED VOLTAGE**

All units are suitable for use on supplies 230-240 V AC.

**FOR OTHER COUNTRIES** ..... 115 V/230 V

**FOR YOUR SAFETY**

Units shipped to countries other than the above countries are equipped with an AC voltage selector switch on the rear panel. Refer to the following paragraph for the proper setting of this switch.

**AC VOLTAGE SELECTION**

This unit operates on 115/230 V AC. The AC voltage selector switch on the rear panel is set to the voltage that prevails in the area to which the unit is shipped. Before connecting the power cord to your AC outlet, make sure that the setting position of this switch matches your line voltage. If not, it must be set to your voltage in accordance with the following direction.

AC voltage selector switch

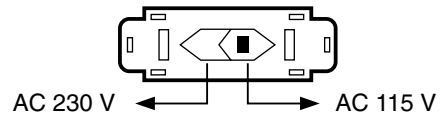

Move switch lever to match your line voltage with a small screwdriver or other pointed tool.

# CONTENTS

## Introduction

- UNPACKING AND INSTALLATION ..... 2
- READ THIS BEFORE OPERATING YOUR UNIT ..... 3

## System Connections ..... 5

## Front Panel Controls ..... 10

### Universal Remote Controls

- DIGI LINK SYSTEM REMOTE CONTROLS ..... 11
- OPERATING COMPONENTS WITH REMOTE CONTROL ..... 13
- REMOTE CONTROL OPERATION RANGE ..... 13
- LOADING BATTERIES ..... 13
- ENTERING A SETUP CODE ..... 14
- ADDITIONAL INFORMATION ON REMOTE COMMAND CODES ..... 16

### ROOM 2 Remote Controls

- REMOTE CONTROL OPERATION RANGE ..... 17
- LADING BATTERIES ..... 17

### Operations

- LISTENING TO A PROGRAM SOURCE ..... 18
- SURROUND SOUND ..... 21
- ENJOYING SURROUND SOUND ..... 24
- LISTENING TO RADIO BROADCASTS ..... 28
- RECORDING ..... 30
- DIGITAL AUDIO RECORDING WITH MD RECORDER ..... 31
- OTHER FUNCTIONS ..... 32
- ROOM 2 SOURCE PLAYBACK ..... 34

### Using the OSD

- CURRENT STATUS DISPLAY ..... 35

### OSD Menu Settings ..... 35

- SETTING THE POWER AMP ASSIGN ..... 37
- SETTING THE SPEAKER SETUP ..... 38
- SETTING THE FUNCTION SELECT ..... 41
- SETTING THE SURROUND SETUP ..... 47
- SETTING THE CH LEVEL TRIM ..... 49
- SETTING THE ROOM 2 FEED SETUP ..... 50

### Troubleshooting Guide ..... 52

### Specifications ..... 53

# System Connections

- Please be certain that the receiver is unplugged from the AC outlet before making any connections.
- Be sure to connect the white RCA pin cords to the L(left) and the red RCA pin cords to the R(right) jacks when making connections.
- Change the position of the FM indoor antenna until you get the best reception of your favorite FM stations.
- A 75Ω outdoor FM antenna may be used to further improve the reception. Disconnect the indoor antenna before replacing it with the outdoor one.
- Place the AM loop antenna as far as possible from the receiver, TV set, speaker cords and the AC input cord and set it to a direction for the best reception.
- If the reception is poor with the AM loop antenna, an AM outdoor antenna can be used in place of the AM loop antenna.
- Make connections firmly and correctly. If not, poor connections can cause loss of sound, noise or damage to the receiver.
- If the electricity fails or the AC input cord is left unplugged for about 2 weeks, the memorized contents will be lost. Should this happen, memorize them again.

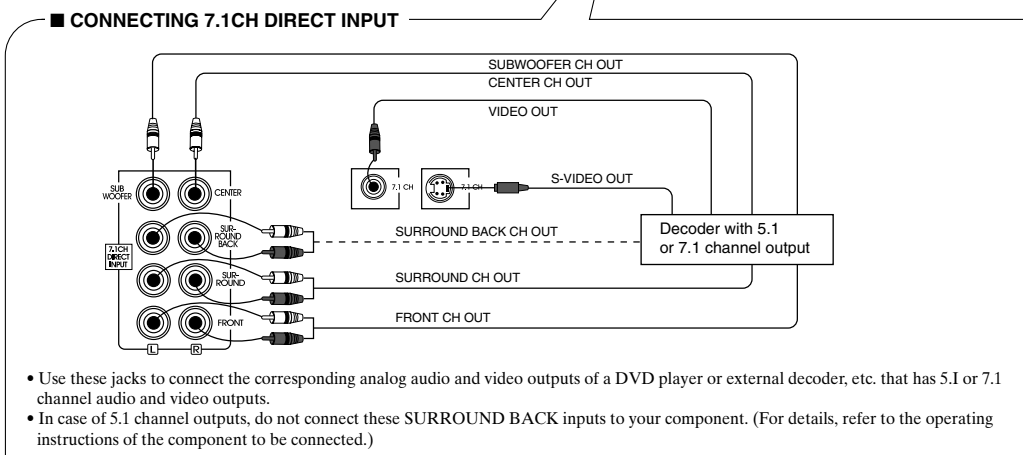
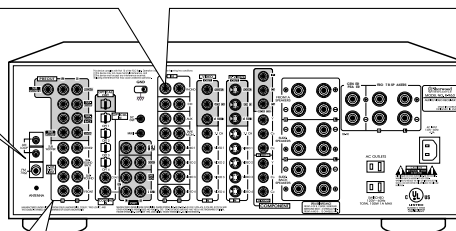
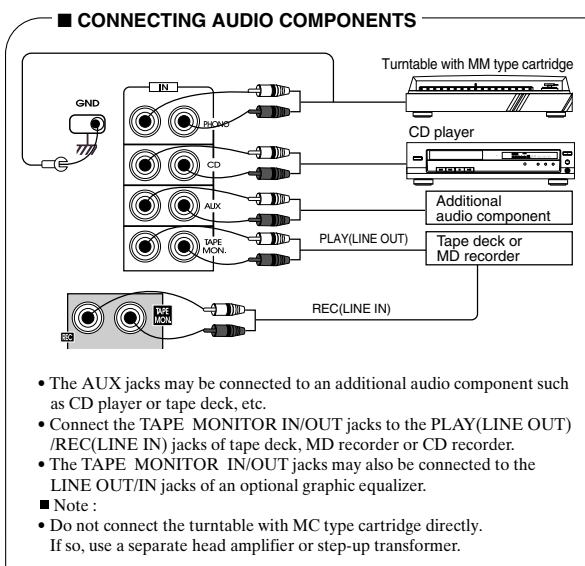
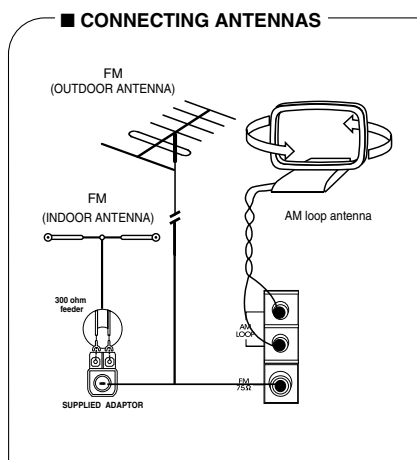

■ CONNECTING VIDEO COMPONENTS

■ AUDIO IN/ OUT connections

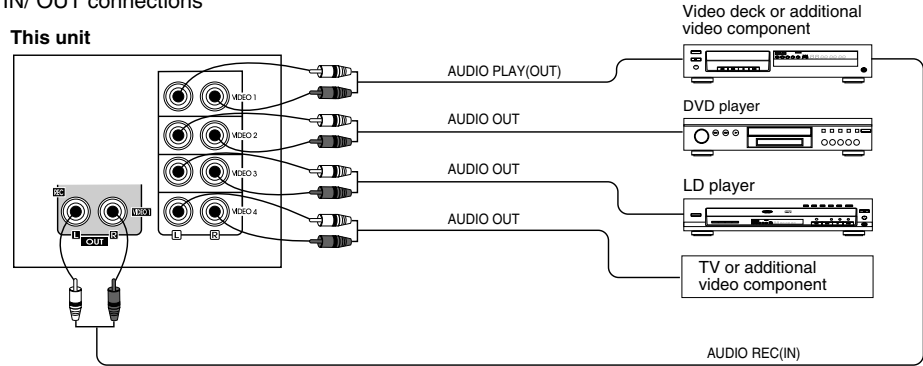

■ VIDEO IN/OUT connections

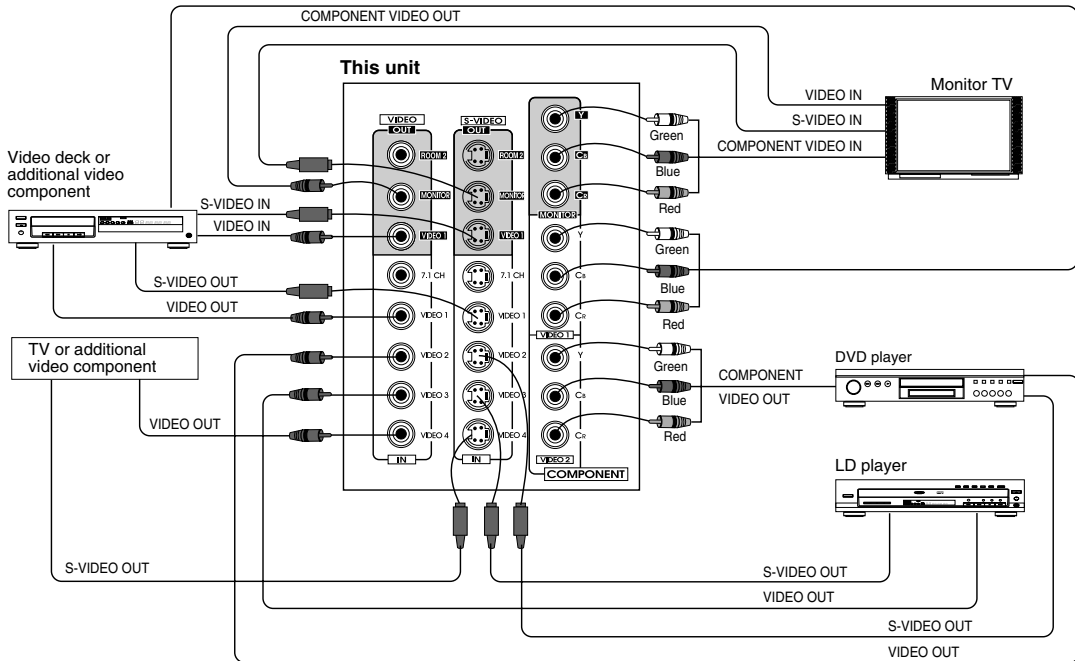

- There are three kinds of video jacks (COMPONENT, S, normal (composite)) for connecting video components. Connect them to the corresponding VIDEO jacks ( VIDEO 1~4) respectively according to their capability.
- The VIDEO 1 jacks may also be connected to a DVD recorder or other digital video recording component.  
For details, refer to the operating instructions of the component to be connected.
- This unit incorporates COMPONENT as well as S and normal(composite) VIDEO jacks.
- For your reference, the excellence in picture quality is as follows: "COMPONENT" > "S" > normal(composite) "VIDEO".
- When making COMPONENT VIDEO connections, connect "Y" to "Y", "Cb" to "Cb" (or "B-Y", "Pb") and "Cr" to "Cr"(or "R-Y", "Pr").
- Signals input into the COMPONENT VIDEO IN jacks will be output in only the MONITOR COMPONENT VIDEO OUT jacks.
- A signal input into the normal(composite) VIDEO IN jack will be output in the normal(composite) VIDEO OUT jacks and a signal input into the S-VIDEO IN jack will be output in the S-VIDEO OUT jacks.
- Notes :
  - Neither on-screen display function nor video recording are available when using the COMPONENT VIDEO connections.
  - When Sherwood DVD player such as V-756, etc. is connected to the DIGI LINK jack for system control, you should connect the DVD player to the "VIDEO 2" jacks of this unit.  
Because, if the PLAY button, etc. is pressed on the DVD player, the VIDEO 2 is automatically selected as an input source on this unit. Then playback, etc. starts.

■ PRE OUT connections

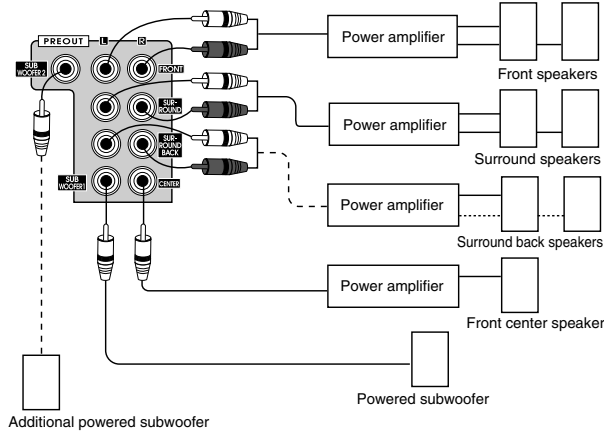

- Use these jacks when adding additional amplifiers.
- Connect the PRE OUT jacks to the powered speakers or the power amplifiers connected to speakers respectively.
- Only when enjoying 6.1 or 7.1 channel surround playback, make the surround back connections between the audio equipment.
- To emphasize the deep bass sounds, connect a powered subwoofer.
- To enjoy deeper bass sounds, connect an additional powered subwoofer to the SUBWOOFER 2 jack.

■ CONNECTING SYSTEM CONTROL

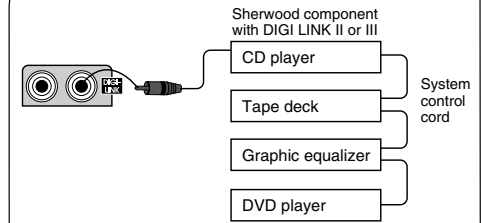

- Connect this jack to the DIGI LINK jack of the external Sherwood component that uses the DIGI LINK II or III remote control system.

■ CONNECTING DC OUT



- Connect a component that needs to be triggered by DC under certain conditions (screen, power strip, etc.) (For details, refer to the operating instructions of the component to be connected.)
- Note
- This output voltage (15 V DC) is for (status) control only, it is not sufficient for drive capability.

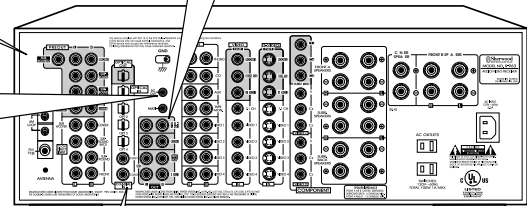

■ CONNECTING DIGITAL INs and OUT

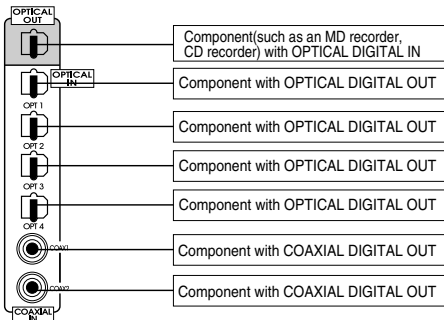

- A digital input should be connected to the components such as LD player, CD player or DVD player, etc. capable of outputting DTS, Dolby Digital or PCM format digital signals, etc.
- If the component with OPTICAL IN jack is connected to the OPTICAL OUT jack of this unit, you can record the high quality sound of CDs, etc. without degradation.
- For details, refer to the operating instructions of the connected component.
- When making the COAXIAL DIGITAL connection, be sure to use a 75 Ω COAXIAL cord, not a conventional AUDIO cord.
- All of the commercially available optical fiber cords cannot be used for the equipment. If you have a question about the suitability of a particular cord, please consult your dealer or nearest service organization.
- The COAXIAL or the OPTICAL DIGITAL OUTs of the components that are connected to CD, TAPE MONITOR and VIDEO 1-VIDEO 5 of this unit can be connected to these DIGITAL INs.
- Notes :
  - After making digital connections, be sure to match the DIGITAL INs to the corresponding input source respectively. (For details, refer to "When selecting the DIGITAL IN SETUP" on page 41.)

ROOM 2 connections

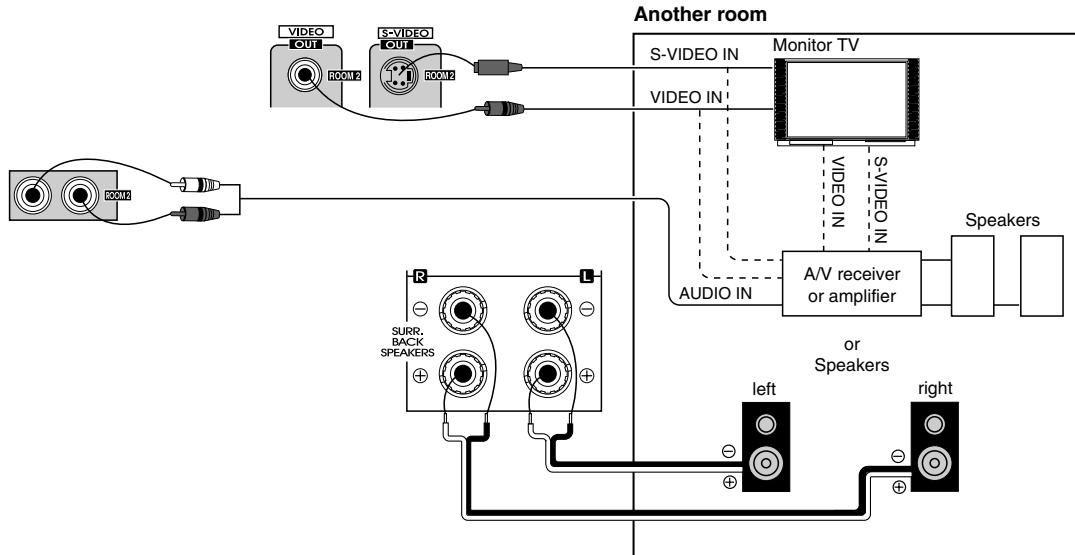

- If another A/V receiver or integrated amplifier, etc. is connected to these jacks, you can play a different program source in another room as well as one source in the main room at the same time. (For details, refer to "ROOM 2 SOURCE PLAYBACK" on page 34).
- However, in case that you do assign the power amplifier for the surround back channels to the ROOM 2 and install the speakers connected to these channels in another room, you need not use the power amplifier to drive the speakers additionally in another room. (For details, refer to "SETTING THE POWER AMP ASSIGN" on page 37.)
- When the multi-room system kit is connected, the ROOM 2 function is more convenient.
- Note:
  - To minimize hum or noise, use high quality connection cords.

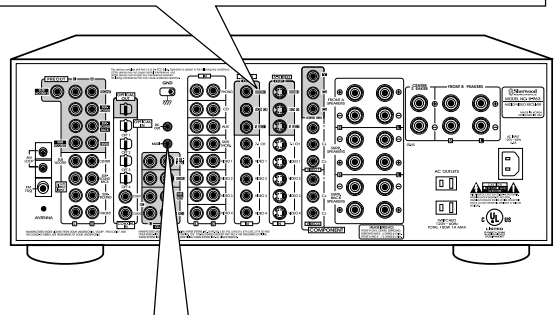

CONNECTING MULTI-ROOM SYSTEM KIT

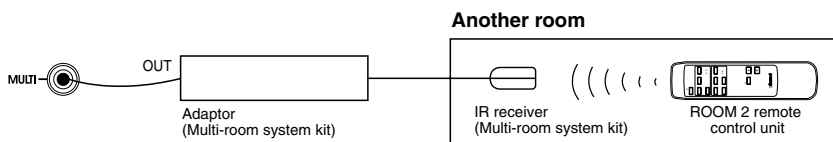

- To control this unit from a remote location, connect this jack to the output of the multi-room adaptor. For information on the multi-room system kit, contact the Xantech corporation at 1-800-843-5465 or [www.xantech.com](http://www.xantech.com).



■ AC INLET

Plug the supplied AC input cord into this AC INLET and then into the wall AC outlet.

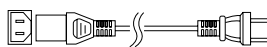

To a wall AC outlet.

- Do not use an AC input cord other than the one supplied with this unit. The AC input cord supplied is designed for use with this unit and should not be used with any other device.

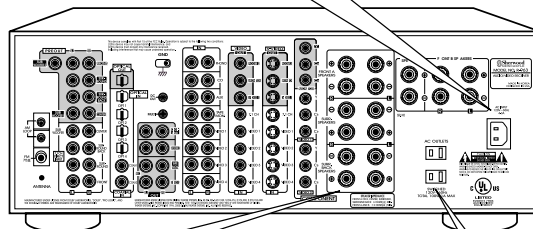

■ CONNECTING SPEAKERS

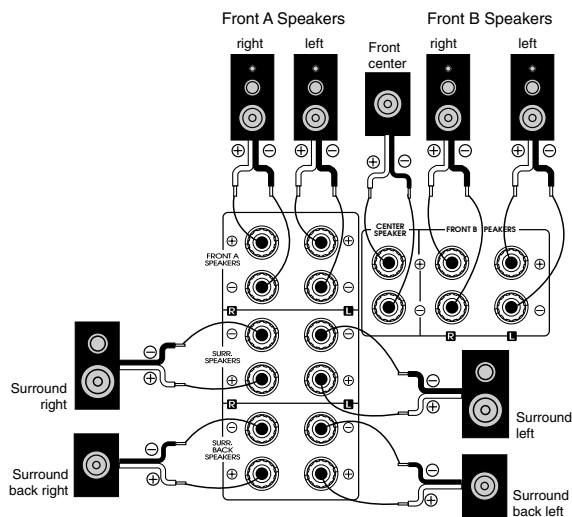

- You can connect two sets of front speakers and can select front A or (and) B speakers according to your taste.
- Never short circuit the + and - speaker wires.
- Be sure to connect speakers firmly and correctly according to the channel (left and right) and the polarity (+ and -).
- Only when enjoying either 6.1 or 7.1 channel surround playback, connect either the surround back left speaker only or both of surround back speakers.
- If you assign the power amplifier for the surround back channels to the ROOM 2, this receiver can drive the speakers in another room (ROOM 2). (For details, refer to "ROOM 2 connections" on the previous page and "SETTING THE POWER AMP ASSIGN" on page 37.)

■ Notes:

- For safe amplifier operation, in case of using either front A or front B speakers, use all the speakers with impedance of over 6 Ω. However, in case of using both front A and front B speakers, use only the front speakers with impedance of over 12 Ω and other speakers with impedance of over 6 Ω.
- After installing the speakers, first set the connected speakers to the desired before operating this receiver. (For details, refer to "SETTING THE SPEAKER SETUP" on page 38.)

■ SWITCHED AC OUTLETS

- These outlets are switched on (power-on mode) and off (standby mode) according to the power control as follows (Maximum total capacity is 1A, 100W):

- Standby mode – switched AC outlet off
- Power-on mode – switched AC outlet on

# Front Panel Controls

ENGLISH

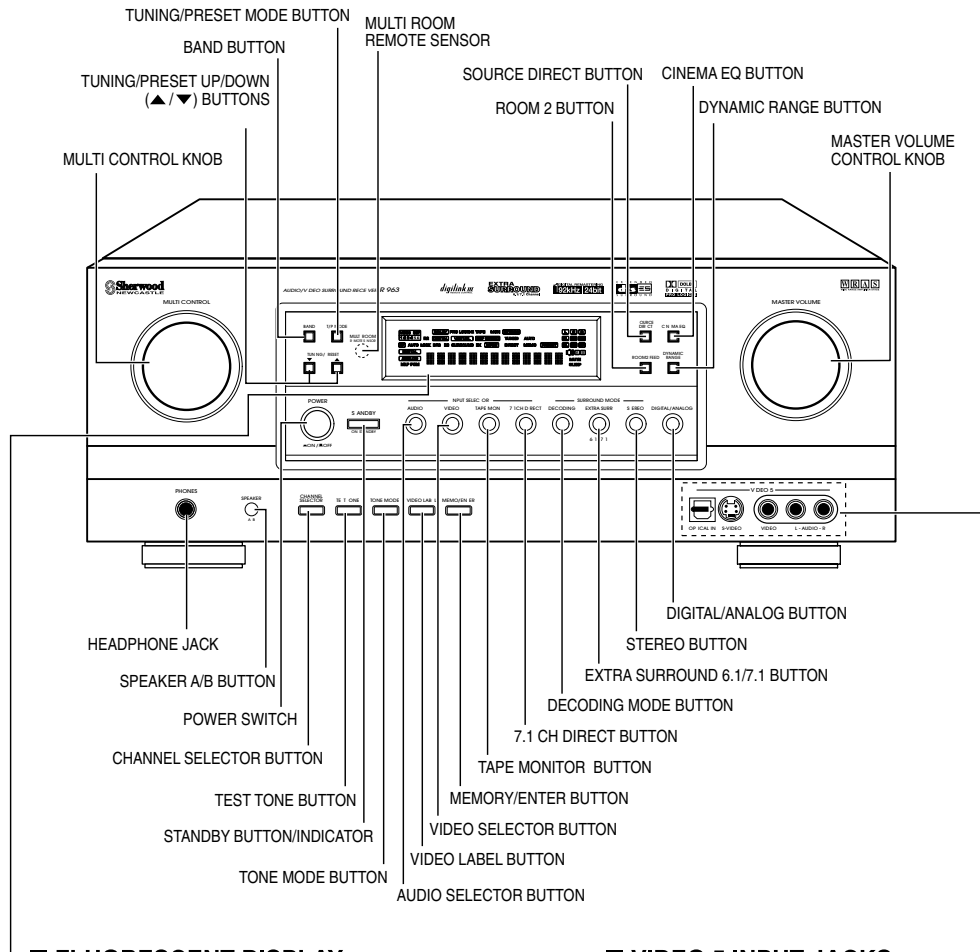

## FLUORESCENT DISPLAY

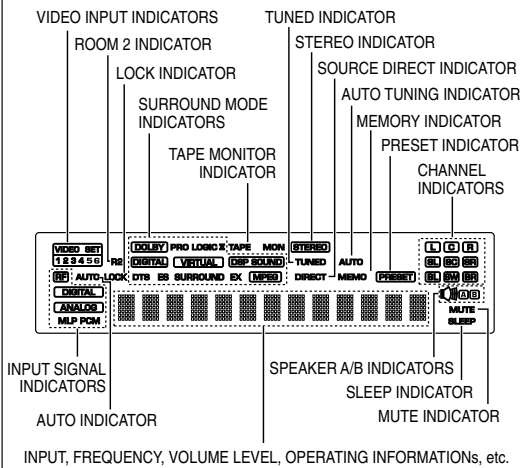

## VIDEO 5 INPUT JACKS

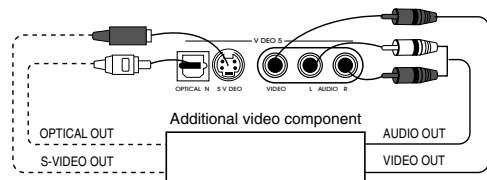

- The VIDEO 5 input jacks may be also connected to an additional video component such as a camcorder, a video deck or a video game player, etc.  
Use the S-VIDEO jack to make connection to video component with the S-VIDEO OUT jack.
- A signal input into the normal(composite) VIDEO jack will be output in the normal(composite) VIDEO OUT jacks and a signal input into the S-VIDEO jack will be output in the S-VIDEO OUT jacks.
- The OPTICAL DIGITAL OUTs of the components that are connected to CD, TAPE MONITOR and VIDEO 1~VIDEO 5 of this unit can be connected to this OPTICAL IN.
- After making digital connections, be sure to match the DIGITAL INs to the corresponding input source respectively.(For details, refer to "When selecting the DIGITAL IN SETUP" on page 41.)
- This OPTICAL IN should be connected to the component capable of DTS, Dolby Digital or PCM format digital signals, etc.

# Universal Remote Controls

■ Note: For enhanced Universal Remote Programming instructions and manufacturer's codes, please refer to the operating manual inclosed with this Universal Remote Control.

This remote control unit has 3 operating modes as follows:

- OSD (On-Screen Display) mode: Allows you to look at information about basic operation of this unit on your monitor TV and to operate this unit by moving an arrow that appears on the screen of your monitor TV.
- Sherwood mode: Allows you to operate this unit and other Sherwood components like cassette decks, CD players, etc.(To operate other Sherwood components, you should make the DIGI LINK connections between them.)
- Non-Sherwood mode: Allows you to operate non-Sherwood audio and video components that are remote compatible.

■ Notes:

- The setup code for each component must be entered before operation.
- For setup codes(manufacturer's codes), please refer to "Set-Up Code Table" in the operating manual of this remote control.
- Some operation buttons have different functions according to each operation mode.
- Be sure to set the remote control to the correct mode before operation.

## DIGI LINK SYSTEM REMOTE CONTROLS

- This section explains the basic functions for Sherwood or OSD mode. For the non-Sherwood mode, refer to the operating manual of this remote control.
- All Sherwood components bearing the DIGI LINK(II or III) logo can be used with this remote control.
- For system remote control operation, first make the DIGI LINK connections between Sherwood components.
- The numbered buttons on the remote control have different functions in different modes. For details, refer to the "FUNCTION TABLE of the NUMBERED BUTTONS" on the following page.
- In the DIGI LINK III remote control system, if pressing PLAY, etc. on CD player or tape deck, CD or TAPE MONITOR is selected automatically on the receiver without selecting the input source. Then PLAY, etc. starts.

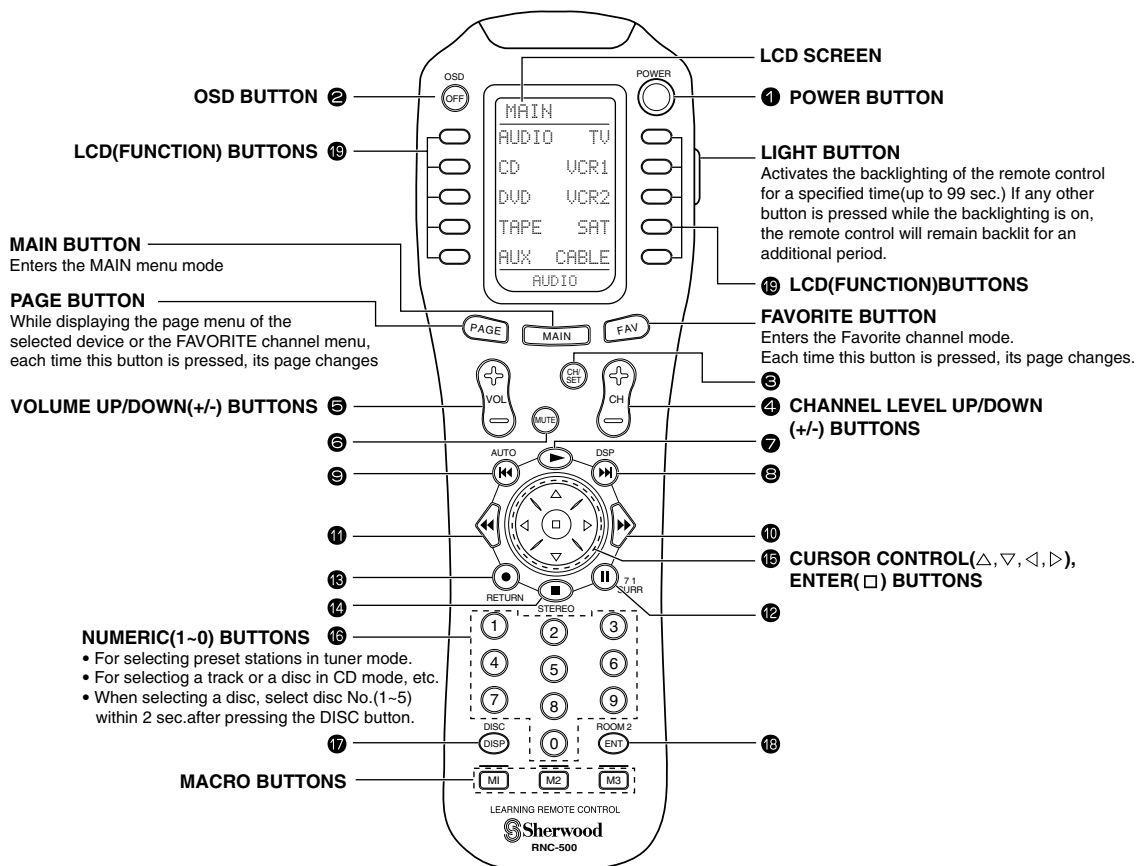

## ■ FUNCTION TABLE of the NUMBERED BUTTONS.

Button symbol	Device to be controlled	AUDIO (for receiver, "001")	CD (for CD player, "001")	TAPE (for tape deck, "001")	DVD (for DVD player)			
					V-756, etc. ("001")	VD-4103, etc. ("112")	VD-2103, etc. ("114")	VD-4106, etc. ("091")
1		POWER	<POWER>	<POWER>	POWER	—	POWER	POWER
2		ON-SCREEN DISPLAY	<ON-SCREEN DISPLAY>	<ON-SCREEN DISPLAY>	MENU	MENU	MENU	MENU
3		CHANNEL SELECTOR	<CHANNEL SELECTOR>	<CHANNEL SELECTOR>	—	—	—	—
4		CH LEVEL UP(+)	<CH LEVEL UP(+)>	<CH LEVEL UP(+)>	—	—	—	—
		CH LEVEL DOWN(-)	<CH LEVEL DOWN(-)>	<CH LEVEL DOWN(-)>	—	—	—	—
5		VOLUME UP(+)	<VOLUME UP(+)>	<VOLUME UP(+)>	—	VOLUME UP(+)	VOLUME UP(+)	—
		VOLUME DOWN(-)	<VOLUME DOWN(-)>	<VOLUME DOWN(-)>	—	VOLUME DOWN(-)	VOLUME DOWN(-)	—
6		MUTE	< MUTE>	< MUTE>	—	—	MUTE	—
7		—	PLAY	FORWARD PLAY	PLAY	STEP	STEP	PLAY
8		DSP MODE	<DSP MODE>	<DSP MODE>	FORWARD SKIP	FORWARD SKIP	FORWARD SKIP	FORWARD SKIP
9		AUTO/MANUAL	<AUTO/MANUAL >	<AUTO/MANUAL >	REVERSE SKIP	REVERSE SKIP	REVERSE SKIP	REVERSE SKIP
10		—	FORWARD SKIP	FAST FORWARD	FORWARD SEARCH	FORWARD SEARCH	FORWARD SEARCH	FORWARD SEARCH
11		—	REVERSE SKIP	REWIND	REVERSE SEARCH	REVERSE SEARCH	REVERSE SEARCH	REVERSE SEARCH
12		7.1 CH SURROUND	PAUSE	PAUSE	PAUSE	PAUSE	PAUSE	PAUSE
13		RETURN	—	RECORD	RETURN	RETURN	RETURN	RETURN
14		STEREO	STOP	STOP	STOP	STOP	STOP	STOP
15		△ CURSOR UP(▲)	<CURSOR UP(▲)>	<CURSOR UP(▲)>	CURSOR UP(▲)	CURSOR UP(▲)	CURSOR UP(▲)	CURSOR UP(▲)
		▽ CURSOR DOWN(▼)	<CURSOR DOWN(▼)>	<CURSOR DOWN(▼)>	CURSOR DOWN(▼)	CURSOR DOWN(▼)	CURSOR DOWN(▼)	CURSOR DOWN(▼)
		▷ CURSOR RIGHT(►)	<CURSOR RIGHT(►)>	<CURSOR RIGHT(►)>	CURSOR RIGHT(►)	CURSOR RIGHT(►)	CURSOR RIGHT(►)	CURSOR RIGHT(►)
		◁ CURSOR LEFT(◄)	<CURSOR LEFT(◄)>	<CURSOR LEFT(◄)>	CURSOR LEFT(◄)	CURSOR LEFT(◄)	CURSOR LEFT(◄)	CURSOR LEFT(◄)
		□ ENTER	<ENTER>	<ENTER>	ENTER	ENTER/PLAY	ENTER/PLAY	ENTER/SELECT
16		0-9	—	—	0-9	0/10-9	0/10-9	0-9
17		SYSTEM DISPLAY	DISC	<SYSTEM DISPLAY>	DISC	ON-SCREEN DISPLAY	DISPLAY	DISPLAY
18		ROOM2	<ROOM2 >	<ROOM2 >	—	—	—	—
P A G E 1		(Left 1) TUNER	PLAY	DECK SELECTOR A	SETUP	SETUP	SETUP	SETUP
		(Left 2) CD	REVERSE SKIP	REVERSE PLAY	TITLE	TITLE	TITLE	TITLE
		(Left 3) TAPE MONITOR	STOP	RECORD	AUDIO	—	AUDIO	AUDIO
		(Left 4) AUX	REPEAT A<>B	REWIND	SUBTITLE	SUBTITLE	SUBTITLE	SUBTITLE
		(Left 5) PHONO	—	STOP	DISPLAY	—	—	SOUND
		(Right 1) VIDEO 1	PAUSE	DECK SELECTOR B	OPEN/CLOSE	OPEN/CLOSE	OPEN/CLOSE	OPEN/CLOSE
		(Right 2) VIDEO 2	FORWARD SKIP	FORWARD PLAY	ZOOM	—	—	ZOOM
		(Right 3) VIDEO 3	INTRO SCAN	PAUSE	SEARCH	—	SEARCH	SEARCH
		(Right 4) VIDEO 4	—	FAST FORWARD	REPEAT A<>B	REPEAT A<>B	REPEAT A<>B	REPEAT A<>B
		(Right 5) VIDEO 5	—	—	REPEAT MODE	REPEAT MODE	REPEAT MODE	REPEAT
P A G E 2		(Left 1) AUTO/MANUAL	<DSP MODE>	<DSP MODE>	MARKER	CHANNEL	—	MARKER
		(Left 2) DTS	<PRO LOGIC II MUSIC>	<PRO LOGIC II MUSIC>	INTRO SCAN	INTRO SCAN	RESUME	RESUME
		(Left 3) DOLBY DIGITAL	<DTS NEO 6 MUSIC>	<DTS NEO 6 MUSIC>	RANDOM	—	L/R/ST	RANDOM
		(Left 4) PCM	<7.1 CH SURROUND >	<7.1 CH SURROUND >	SUBTITLE ON/OFF	V-MODE	PBC	ANGLE
		(Left 5) DIGITAL/ANALOG	<STEREO>	<STEREO>	ANGLE	ANGLE	—	—
		(Right 1) 7.1 CH DIRECT	<7.1CH DIRECT>	<7.1 CH DIRECT>	PROGRAM	PROGRAM	PROGRAM	PROGRAM
		(Right 2) SOURCE DIRECT	<SOURCE DIRECT >	<SOURCE DIRECT >	CLEAR	MEMORY	KEY UP	CLEAR
		(Right 3) SLEEP	< SLEEP>	< SLEEP>	TIME	A-TIME	KEY DOWN	REVERSE SLOW
		(Right 4) PRESET SCAN	< SYSTEM DISPLAY>	< SYSTEM DISPLAY>	SLOW	SLOW	SLOW	FORWARD SLOW
		(Right 5) TEST TONE	<DIGITAL/ANALOG>	—	PAL/NTSC	PAL/NTSC	PAL/NTSC	—

### ■ Notes:

- Some functions for CD player, tape deck, DVD player, etc. may not be available.
- For details about functions, refer to the operating instructions of each component.
- The functions in <> work for this receiver, not for the CD player or tape deck.

## OPERATING COMPONENTS WITH REMOTE CONTROL

**1** Enter the setup code of the components respectively, referring to “ENTERING A SETUP CODE”(page 14).

**2** Turn on the components you want to operate.

**3** Select the device on the main menu of the remote control corresponding to the component you want to operate.

Example) When selecting “AUDIO” to operate this receiver.

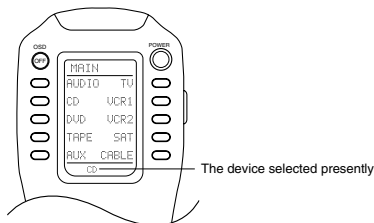

• Then the page menu of the selected device will be displayed.

**4** Press the button corresponding to the operation you want while aiming the remote control at the REMOTE SENSOR on the component.

- When operating a Sherwood CD player or tape deck using the system remote control, aim the remote control at the REMOTE SENSOR on this unit.
- However, in case of Sherwood DVD player, aim it at the REMOTE SENSOR on the corresponding component.
- To select a function on the page menu of the selected device.
- Find the function by pressing the PAGE button repeatedly and then press the button corresponding to the desired function.

Example) when selecting a function on the AUDIO's page menu.

Functions on the page 1

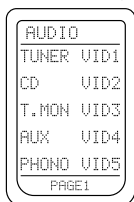

Functions on the page 2

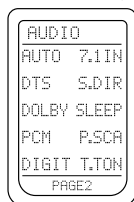

## REMOTE CONTROL OPERATION RANGE

- Use the remote control within a range of about 7 meters (23 feet) and angles of up to 30 degrees aiming at the remote sensor.

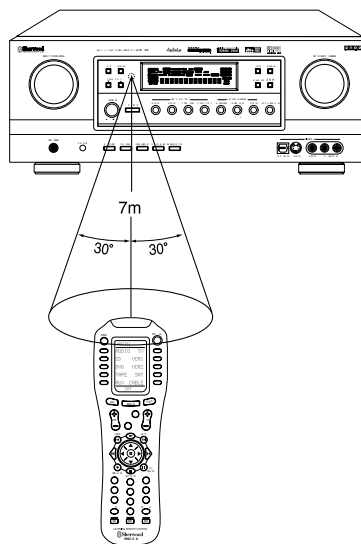

## LOADING BATTERIES

- When the remote control does not operate or “LOW BATTERY” is displayed on the LCD screen, etc., the old batteries should be replaced.

**1** Remove the cover.

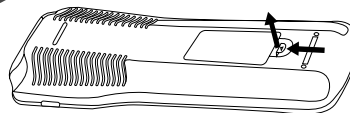

**2** Load four alkaline batteries (“AAA” size, 1.5V) matching the polarity.

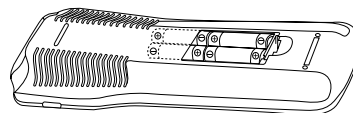

## ENTERING A SETUP CODE

- This remote control can control up to ten different components.
- Before operating audio and video components using the remote control supplied with this receiver, the setup code for each component should be entered.
- For system remote control operation, the setup code for each Sherwood component such as CD player, tape deck and DVD player(V-756, etc.) is "001" respectively. (However, the setup code for some Sherwood DVD player such as VD-4103, etc. is "112", "114" or "091". Enter each setup code for CD player and tape deck doing from step ③ as follows.

### 1

Turn on the component you want to control.

Example) When entering the setup code for this receiver, turn on this receiver.

■ Note:

- If you component has the discrete POWER ON and OFF buttons, please do not turn on the component manually.

### 2

Find the setup code for your component referring to "Set-Up Code Table" in the operating manual of this remote control.

Example) The 3 digit setup codes for the Sherwood "Audio" are 001,024, ...(Hint:The correct setup code for this receiver is "001".)

### 3

Press both the MAIN and ROOM 2(/ENTER) buttons simultaneously for 3 seconds.

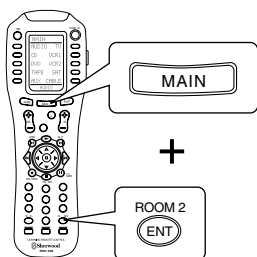

- Then the setup menu will be displayed on the LCD screen.

■ Note:

- If the display of the corresponding mode disappears, start again from the above step ③ or the current mode.

### 4

Select the Pre-PROgramming mode.

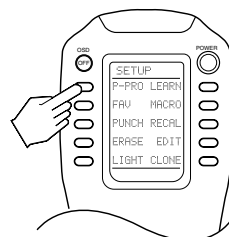

- Then the Pre-PROgramming menu will be displayed.

### 5

Select the device corresponding to the component you want to control.

Example) When selecting the AUDIO for receiver or amplifier, etc.

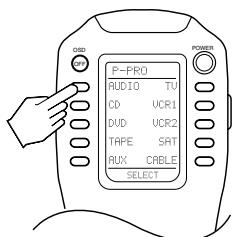

### 6

Select the device from which the appropriate 3 digit setup code table will be selected.

Example) If it is the AUDIO code table, select the AUDIO.

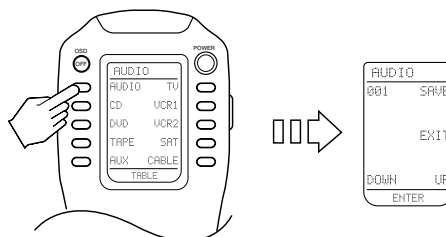

**7** Enter the 3 digit setup code aiming the remote control at the REMOTE SENSOR on the component.

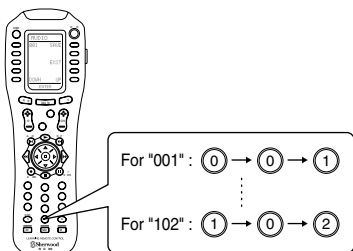

- Your component will be turned off when the right code is entered.
- Continue to enter the corresponding codes until your component turns off.

**8** Confirm that it is the right code by pressing the POWER button and then save the code.

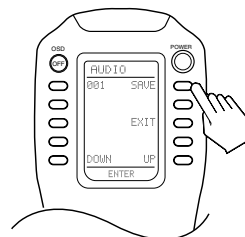

- The code is saved and the Pre-PROgramming mode is resumed.
- When you do not want to save the code, select the EXIT on the LCD screen or press the MAIN button.

**9** To resume the MAIN menu mode, press the MAIN button twice briefly.

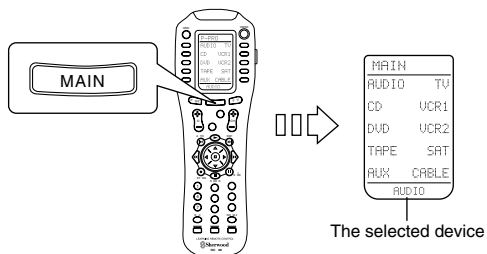

- Each time the MAIN button is pressed, the previous mode is resumed.

**10** Operate the component using the corresponding function buttons.

- If any of the buttons fails to operate as they should, start from the step ① again to enter the next setup code.
- Notes:
  - If the Manufacturer/Brand for your component is not listed in "Set-Up Code Table" in the operating manual of this remote control, please use the "2 Auto Scan Method" on page 13 in the operating manual of this remote control.
  - Although each setup code is designed to work with many different modes, certain codes may not work with some models. (Also, certain codes may only operate some of the functions available on a given model.)

**11** Repeat the above steps ① to ⑩ for each of your other components.

## ADDITIONAL INFORMATION ON REMOTE COMMAND CODES

- This receiver recognizes and responds to IR codes that are not transmitted by the supplied remote control unit. These commands and their corresponding functions, shown on the following table, are made available for custom installers and advanced hobbyists who are already familiar with the programming of such devices as the Crestron Touch Screen and the Philips Pronto.

Custom Code : 8345H(NEC)

FUNCTIONS	MAIN CODES	FUNCTIONS	MAIN CODES
DTS	70H	VIDEO 1	56H
Dolby Digital	71H	VIDEO 2	5AH
EXTRA SURROUND 6.1/7.1	44H	VIDEO 3	07H
DECODING MODE	58H	VIDEO 4	5BH
STEREO	4FH	VIDEO 5	5DH
DIGITAL/ANALOG	E1H	PHONO	02H
Dolby Pro Logic II Movie	E8H	TUNER	03H
Dolby Pro Logic II Music	E9H	TAPE MONITOR	06H
DTS Neo Movie	EDH	AUX	0AH
DTS Neo Music	EEH	CD	0BH
MPEG	EBH	7.1 CH DIRECT	4AH
PCM	EFH	SOURCE DIRECT	7BH
DSP MODE	5CH		

Custom Code : 8345BH(NEC)

FUNCTIONS	ROOM 2 CODES	FUNCTIONS	ROOM 2 CODES
ROOM 2	91H	AUX	8FH
MUTE	C3H	CD	8BH
VOLUME UP	C7H	VIDEO 1	8AH
VOLUME DOWN	CBH	VIDEO 2	8CH
PHONO	82H	VIDEO 3	90H
TUNER	83H	VIDEO 4	C2H
TAPE MONITOR	86H	VIDEO 5	C1H

- These are codes for ROOM 2 source playback only.



# ROOM 2 Remote Controls

This remote control unit is an additional remote control unit for the ROOM 2 source playback only.

- Operation of ROOM 2 functions may be easier and more convenient with this remote control instead of using the universal remote control.

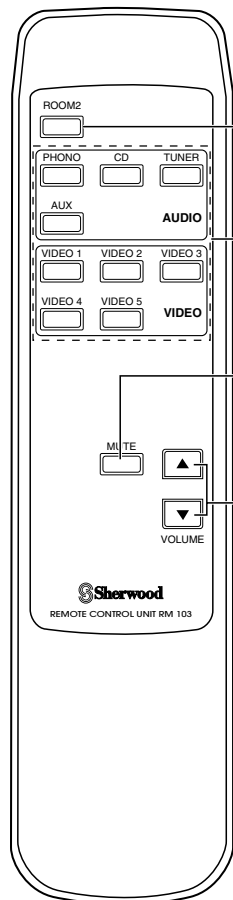

### ROOM 2 BUTTON

Each time this button is pressed, the ROOM 2 function is activated or canceled.

### ROOM 2 INPUT SELECTOR BUTTONS

When one of these buttons is pressed, the corresponding input source is selected.

### MUTE BUTTON

Mutes the sound of the ROOM2 source.

- To resume the previous sound level, press it again.

### VOLUME UP/DOWN(Δ/▽) BUTTONS

Adjust the sound volume of the ROOM 2 source.

## REMOTE CONTROL OPERATION RANGE

- Aim the ROOM 2 remote control(or the universal remote control) at the IR receiver installed in another room.(For details, refer to “CONNECTING MULTI-ROOM SYSTEM KIT” on page 8.)

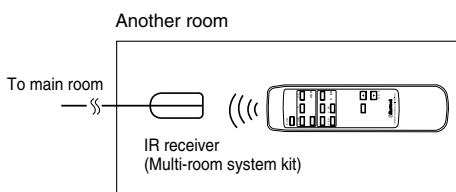

- When you operate the ROOM 2 function in the main room, aim the universal remote control(or the ROOM 2 remote control) at the remote sensor of this receiver.

## LOADING BATTERIES

1

Remove the cover.

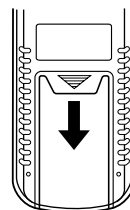

2

Load two batteries (“AAA” size, 1.5V ) matching the polarity.

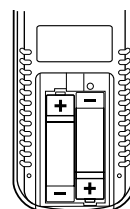

# Operations

- Notes : • Before operating this receiver with the supplied remote control, refer to “Universal Remote Controls” on page 11 for details about operation.
- Before operating this receiver, first set this unit as desired for optimum performance, by using the OSD menu setting procedures. (For details, refer to “OSD Menu Settings” on page 35.)

## LISTENING TO A PROGRAM SOURCE

### Before operation

- Enter the standby mode.



- The STANDBY button lights up in red. This means that the receiver is not disconnected from the AC mains and a small amount of current is retained to support the memorized contents and operation readiness.
- To switch the power off, push the POWER switch again.
- Then power is cut off and the STANDBY button goes off.

1

In the standby mode, turn the power on.

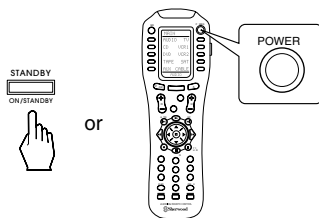

- Each time the STANDBY button on the front panel or the POWER button on the remote control is pressed, the receiver is turned on to enter the operating mode (the STANDBY button lights up in blue) or off to enter the standby mode (the STANDBY button lights up in red).
- In the standby mode, if one of the INPUT SELECTOR buttons is pressed, the receiver is turned on automatically and the desired input is selected.

2

Switch the desired front speakers on.



- Each time this button is pressed, the speaker mode changes as follows and the sound can be heard from the speakers connected to the selected front speaker terminals:

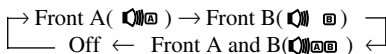

- When using the headphones for private listening, select the Off mode to switch off the front speakers and all the others.

3

Select the desired input source.

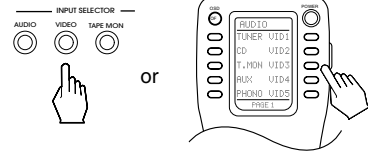

- Each time the “AUDIO” button is pressed, the input source changes as follows:

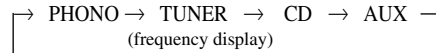

- Each time the “VIDEO” button is pressed, the input source changes as follows:

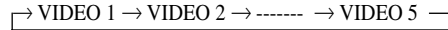

- When the TAPE MONITOR button is set to on so that “TAPE MON” lights up, other inputs can not be heard from the speakers.

To listen to an input source except TAPE MONITOR, be sure to set the TAPE MONITOR button to off.

### TAPE MONITOR function

You can connect either a tape deck or a graphic equalizer to the receiver’s TAPE MONITOR jacks.

Only when you listen to the component connected to these jacks, set the TAPE MONITOR button to on.

If you connect a 3-head tape deck, you can listen to the sound being recorded during recording, and not the source sound. For further details, refer to the operating instructions of the connected component.

- When selecting the 7.1 CH DIRECT as desired

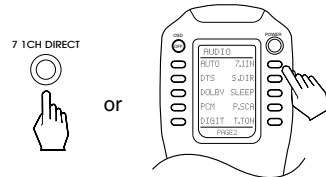

- Depending on the power amplifier setting for the surround back channels and the surround back speaker setting, “7.1(6.1 or 5.1) CH DIRECT” is displayed and the 8(7/6) separate analog signals from the component connected to this input pass through the tone, volume and bass management (if selected) circuits only and can be heard from your speakers. (In case that the TAPE MONITOR button is set to on, the TAPE MONITOR button is automatically set to off.)

- Press the 7.1 CH DIRECT button or select the desired input source to cancel the 7.1 CH direct function.

- These analog signals can be heard only. They cannot be recorded.

### When CD, TAPE MON or VIDEO 1~VIDEO 5 is selected

**4** Select the digital or the analog input as desired.

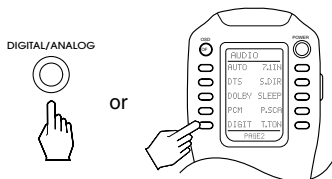

- Each time this button is pressed, the corresponding input is selected as follows:

→ DIGITAL → ANALOG

- To listen to DTS, Dolby Digital or MPEG program sources in the 2-CH downmix mode, in the stereo mode, the digital input must be selected. (For details, refer to “Downmixing into 2 front channels” on page 27.)
- When PHONO, TUNER or AUX is selected as an input source, the analog input is automatically selected.

■ Notes:

- When the selected digital input is not connected, “DIGITAL” flickers, meaning no sound. (Refer to “ENJOYING SURROUND SOUND” on page 24.)
- To select the digital input, you must match the connected DIGITAL IN to the corresponding input source. (For details, refer to “When selecting the DIGITAL IN SETUP” on page 41.)

**5** Operate the selected component for playback.

- When playing back the program sources with surround sound, refer to “ENJOYING SURROUND SOUND” on page 24.

**6** Adjust the (overall) volume.

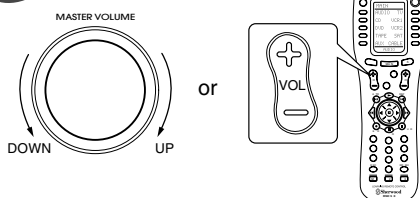

### Adjusting the tone (bass and treble)

**7** Select the tone mode as desired.

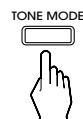

- Each time this button is pressed, the tone mode changes as follows:

→ BASS → TREBLE → DEFEAT OFF(or ON)

- The tone display is shown for 5 seconds.
- If the tone display disappears, press the TONE MODE button again.
- ( ) : When the tone defeat function is activated (“DEFEAT ON”), bass and treble modes cannot be selected

■ Note:

- When the source direct function is activated, the tone mode cannot be selected.

**8** At the desired tone mode, adjust as desired.

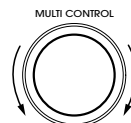

- At the tone defeat mode, each time the MULTI CONTROL knob is rotated, the tone defeat mode changes as follows:

DEFEAT ON : When listening to a program source without the tone effect.  
 ↓  
 DEFEAT OFF : When adjusting the tone for your taste.

- At the desired tone (bass or treble), each time the MULTI CONTROL knob is rotated, the tone level can be adjusted within the range of +10~ -10 dB.
- In general, we recommend the bass and treble to be adjusted to 0(flat) level.
- To complete tone adjustment, repeat the above steps ⑦ and ⑧.
- Extreme settings at high volume may damage your speakers.

9

To achieve the pure sound quality.

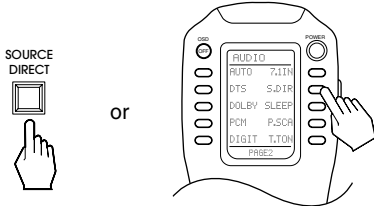

- Only when playing program sources recorded in analog stereo or digital 2 ch PCM format, the source direct function can be selected.
- “DIRECT” lights up and stereo mode is automatically selected. Then the sound that bypasses the tone circuitry will be heard.
- Press the button again to cancel the source direct function.
- When you select the 7.1 CH DIRECT as input source or the digital signals from DTS, Dolby Digital or MPEG sources, etc. are input, the source direct function is automatically canceled.

10

To compensate for edgy or shrill movie sound tracks.

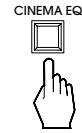

- When 96 kHz PCM(2 channel stereo) signals are input or the source direct function is selected, the cinema EQ function can not be selected.
- “CINEMA-EQ ON” will scroll on the display.
- Press it again to cancel, then “CINEMA-EQ OFF” will scroll on the display.

11

To mute the sound.

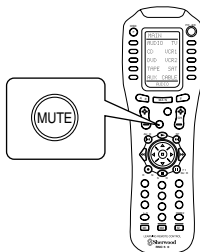

- “MUTE” lights up.
- To resume the previous sound level, press the button again.

12

To listen with the headphones.

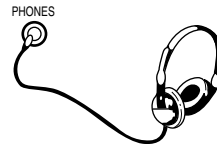

- Ensure that the SPEAKER A/B button is set to the off mode.
- When listening to DTS, Dolby Digital or MPEG program sources, if the headphones are plugged in and the SPEAKER A/B button is set to the off mode, the 2-CH downmix mode will be selected automatically.(For details, refer to “Downmixing into 2 front channels” on page 27.)

## SURROUND SOUND

- This unit incorporates a sophisticated Digital Signal Processor that allows you to create optimum sound quality and sound atmosphere in your personal Home Theater.

### Surround modes

#### ■ DTS Digital Surround

DTS Digital Surround(also called simply DTS) is a multi-channel digital signal format which can handle higher data rates than Dolby Digital. Although both Dolby Digital and DTS are 5.1 channel formats, discs bearing the “” are generally thought to provide better sound quality due to the lower audio compression required.

It also provides wide dynamic range and separation, resulting in magnificent sound.

#### ■ DTS - ES Extended Surround™

This is a new multi channel digital signal format which greatly improves the 360-degree surround impression and space expression thanks to further expanded surround signals, offering high compatibility with the conventional DTS format. In addition to the 5.1 channels, DTS-ES Extended Surround also offers the surround back (sometimes also referred to as “surround center”) channel for surround playback with a total of 6.1 channels. DTS-ES Extended Surround includes two signal formats with different surround signal recording methods as follows:

##### • DTS-ES™ Discrete 6.1

Because the signals for 6.1 channels (including the surround back channel) are fully independent, it is possible to achieve a sense that the acoustic image are moving about freely among the background sounds surrounding the listener from 360 degrees.

Though maximum performance is achieved when sound tracks recorded with this system are played using a DTS -ES decoder, when played with a conventional DTS decoder, the surround back channel signals are automatically downmixed to the surround left and surround right channels so that none of the signal components are lost.

##### • DTS - ES™ Matrix 6.1

With this format, the additional surround back channel signals undergo matrix encoding and are input to the surround left and surround right channels beforehand. During playback, they are decoded to the surround left, surround right and surround back channels. Because the bit stream format is 100% compatible with conventional DTS signals, the effect of the DTS-ES Matrix 6.1 format can be achieved even with DTS 5.1- channel signal sources. Of course, it is possible to play DTS-ES Matrix 6.1 - channel signal sources with a DTS 5.1 - channel decoder.

When DTS-ES Discrete 6.1 or Matrix 6.1 sources are decoded with a DTS -ES decoder, the format is automatically detected upon decoding and the optimum surround mode is selected.

However, some DTS - ES Matrix 6.1 sources may be detected as DTS sources. In this case, the DTS - ES Matrix mode must be selected manually to play these sources.

- In DTS-ES Discrete 6.1 or DTS -ES Matrix 6.1 sources, the surround back channel is monaural, but can be played through a single(in 6.1 mode) or two surround back speakers(in 7.1 mode) depending on the surround back speaker setting. (For details, refer to “SETTING THE SPEAKER SETUP” on page 38.)

#### ■ DTS Neo : 6™ surround

This mode applies conventional 2-channel signals such as digital PCM or analog stereo signals to the high precision digital matrix decoder used for DTS-ES Matrix 6.1 to achieve 6.1-channel surround playback. DTS Neo : 6 surround includes two modes for selecting the optimum decoding for the signal source.

##### • DTS Neo : 6 Movie

This mode is optimum for playing movies. Decoding is performed with emphasis on separation performance to achieve the same atmosphere with 2-channel sources as with 6.1-channel sources.

##### • DTS Neo : 6 Music

This mode is suited mainly for playing music. The front left and front right signals bypass the decoder and are played directly so there is no loss of sound quality, and the effect of the surround signals from the center, surround left, surround right and surround back channels adds a natural sense of expansion to the sound field.

“DTS”, “DTS-ES Extended Surround” and “Neo : 6” are trademarks of Digital Theater Systems, Inc.

#### ■ Dolby Digital

Dolby Digital is the multi- channel digital signal format developed by Dolby Laboratories. Discs bearing the “” includes the

recording of up to 5.1 channels of digital signals, which can reproduce much better sound quality, spatial expansion and dynamic range characteristics than the previous Dolby Surround effect.

#### ■ Dolby Pro Logic

Dolby Pro Logic is a specially encoded two channel surround format which consists of four channels ( front left, center, front right and surround). Sources bearing the “” provide the theater - like surround sound.

The surround channel is monaural, but is played through both surround speakers.

#### ■ Dolby Pro Logic II surround

This mode applies conventional 2- channel signals such as digital PCM or analog stereo signals as well as Dolby Surround signals, etc. to surround processing to offer improvements over conventional Dolby Pro Logic circuits. Dolby Pro Logic II surround includes two modes as follows:

##### • Dolby Pro Logic II MOVIE

When enjoying movies, this mode allows you to further enhance the cinematic quality by adding processing that emphasizes the sounds of the action special effects.

##### • Dolby Pro Logic II MUSIC

When listening to music, this mode allows you to further enhance the sound quality by adding processing that emphasizes the musical effects.

#### ■ Dolby Virtual

This mode employs sophisticated digital processing to create the illusion of “phantom” speakers, this mode allows you to experience surround sound effects from Dolby Digital, Dolby Surround or 2-channel (recorded in digital PCM or analog stereo) sources, through just a single pair of front speakers.

Manufactured under license from Dolby Laboratories.

“Dolby”, “Pro Logic”, and the double-D symbol are trademarks of Dolby Laboratories.

#### ■ MPEG Multichannel

This mode is a surround system which faithfully reproduces the ambience and dynamics of movie soundtracks and music alike. Though the number of audio channels are same as Dolby Digital, discs bearing the “” provides much better at locating individual sounds to the correct and stable position in the sound stage.

#### ■ Extra Surround 6.1/7.1

This mode extracts the surround back (sometimes also referred to as “surround center”) signals from the surround left and surround right signals and reproduce it as well as the original multichannel signals during playback of multi-channel program sources recorded in DTS, Dolby Digital, etc.

- The following modes apply conventional 2-channel signals such as digital PCM or analog stereo signals to high performance Digital Signal Processor to recreate sound fields artificially. Select one of the twelve provided surround modes according to the program source you want to play.

■ **Theater**

This mode provides the effect of being in a theater -in-the round when watching a play.

■ **Movie**

This mode provides the effect of being in a movie theater when watching a movie.

■ **Hall 1/2**

This mode provides the ambience of a chamber hall for chamber music or an instrumental solo (Hall 1) or a concert hall for orchestral music or an opera (Hall 2).

■ **Stadium**

This mode provides the expansive sound field to achieve the true stadium effect when watching baseball or soccer games.

■ **Church**

This mode provides the ambience of a church for baroque, string orchestral or choral group music.

■ **Arena 1/2**

This mode provides the feeling of a live concert in a medium - sized (Arena 1) or large (Arena 2) arena.

■ **Club 1/2**

This mode creates the sound field of a jazz club with a low ceiling and hard walls (Club 1) or a live house with a relatively spacious floor (Club 2).

■ **Game**

Use this mode to enjoy video game sources.

■ **Matrix**

This mode reproduces a delayed signals from the surround channels to emphasize the sense of expansion for music sources.

- When using the 7.1 CH DIRECT INPUTs to play back the sound from an the additional multichannel decoder for surround sound, you can enjoy the corresponding surround sound ,too.( For details, refer to the operating instructions of the component to be connected.)

For your reference, the sound from each channel can be reproduced according to the surround modes as follows:

Modes \ Channels	FRONT L/R	(FRONT) CENTER	SURROUND L/R	SURROUND BACK CENTER, L/R	SUBWOOFER
DTS	○	○	○		○
DTS ES DISCRETE/MATRIX	○	○	○	◎	○
DTS NEO MOVIE/MUSIC	○	○	○	◎	○
DOLBY DIGITAL	○	○	○		○
DOLBY PRO LOGIC	○	○	○		○
DOLBY PRO LOGIC II MOVIE/MUSIC	○	○	○		○
DOLBY VIRTUAL	○				○
MPEG	○	○	○		○
EXTRA SURROUND	○	○	○	◎	○
MATRIX	○	○	○	◎	○
Other Surround	○	○	○		○
STEREO	○				○
7.1 CH DIRECT	○	○	○	◎	○

◎ : Depending on the surround back speaker setting, the sound from the SURROUND BACK CENTER or L/R channels can be reproduced.

- Depending on the speaker settings and the number of the encoded channels, the sound from the corresponding channels cannot be reproduced.(For details, refer to “SETTING THE SPEAKER SETUP” on page 38.)

## Speaker placement

Ideal speaker placement varies depending on the size of your room and the wall coverings, etc. The typical example of speaker placement and recommendations are as follows :

### ■ Front left and right speakers and center speaker

- Place the front speakers with their front surfaces as flush with TV or monitor screen as possible.
- Place the center speaker between the front left and right speakers and no further from the listening position than the front speakers.
- Place each speaker so that sound is aimed at the location of the listener's ears when at the main listening position.

### ■ Surround left and right speakers

- Place the surround speakers approximately 1 meter (40 inches) above the ear level of a seated listener on the direct left and right of them or slightly behind.

### ■ Surround back left and right speakers.

- Place the surround back speakers at the back facing the front at a narrower distance than the front speakers.
- When using a single surround back speaker, place it at the rear center facing the front at a slightly higher position (0 to 10 inches) than the surround speakers.
- We recommend installing the surround back speaker(s) at a slightly downward facing angle. This effectively prevents the surround back channel signals from reflecting off the TV or screen at the front center, resulting in interference and making the sense of movement from the front to the back less sharp.

### ■ Subwoofer

- The subwoofer reproduces powerful deep bass sounds. Place a powered subwoofer anywhere in the front as desired.

### ■ Notes :

- When using a conventional TV , to avoid interference with the TV picture, use only magnetically shielded front left and right and center speakers.
- To obtain the best surround effects, the speakers except the subwoofer should be full range speakers.

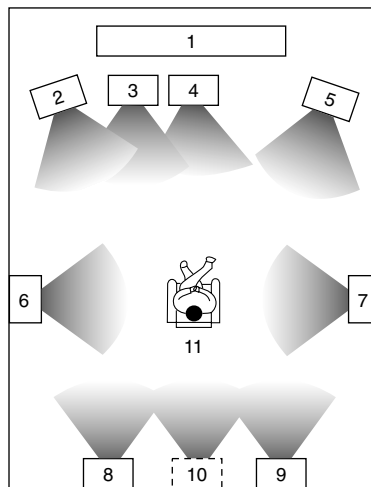

- |                          |                                  |
|--------------------------|----------------------------------|
| 1. TV or screen          | 7. Surround right speaker        |
| 2. Front left speaker    | 8. Surround back left speaker    |
| 3. Subwoofer             | 9. Surround back right speaker   |
| 4. Center speaker        | 10. Surround back center speaker |
| 5. Front right speaker   | 11. Listening position           |
| 6. Surround left speaker |                                  |

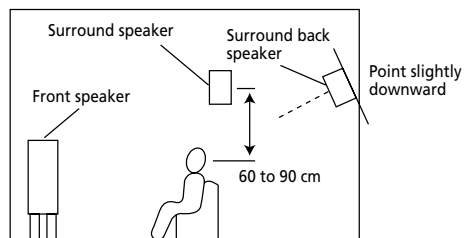

## ENJOYING SURROUND SOUND

- Surround sound effect will not work properly if the signal passes through a graphic equalizer. Please refer to your equalizer operating instructions for guidance on switching off (or defeating) the equalizer.

■ Note:

- Before surround playback, first perform the SPEAKER SETUP procedure, etc. on the OSD menu for optimum performance. (For details, refer to “SETTING THE SPEAKER SETUP” on page 38.)

### 1

Depending on the input digital signal format, select the desired decoding mode.

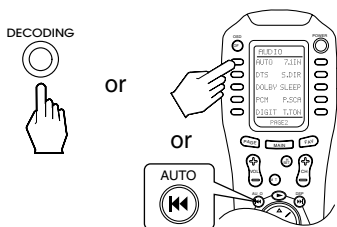

■ Notes :

- Only when the digital input is selected as signal input for the input sources except PHONO, TUNER and AUX, the decoding mode can be selected.
- Noise may be generated at the beginning of playback and while searching during DTS playback in the auto mode. To minimize this possibility try playing in the DTS mode.

- You can select the “DTS”, “DOLBY DIGITAL” or “PCM” mode directly on the remote control.
- Each time the DECODING MODE button on the front panel or the AUTO button on the remote control is pressed, the decoding mode changes as follows :
  - \* Auto mode (“ AUTO” lights up) : The input digital signal format (DTS, Dolby Digital, MPEG or PCM ( 2 channel stereo), etc.) used by the selected digital input source is detected automatically to perform the necessary decoding process for optimum surround modes.
  - \* Dolby Digital mode (“DOLBY DIGITAL” lights up) : The Dolby Digital signal processing is performed only when Dolby Digital signals are input.
  - \* DTS mode (“ DTS” lights up) : The DTS signal processing is performed only when DTS signals are input.
  - \* MPEG mode (“MPEG” lights up) : The MPEG signal processing is performed only when MPEG signals are input.
  - \* PCM mode (“PCM” lights up) : The PCM signal processing is performed only when PCM signals are input.

### 2

Select the desired surround mode.

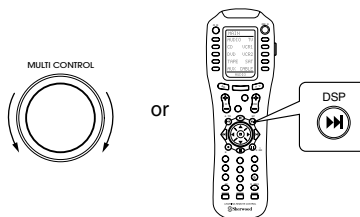

- Each time the MULTI CONTROL knob is rotated or the DSP MODE button is pressed, the surround mode changes depending on the input signal format and the selected decoding mode as follows :

\* When Dolby Digital signals are input in the auto or Dolby Digital mode, the following modes can be selected.

↳ DOLBY DIGITAL (↔ DOLBY PRO LOGIC II MOVIE ↔ DOLBY PRO LOGIC II MUSIC ↔ DOLBY PRO LOGIC) ↔ DOLBY VIRTUAL

Only when Dolby Digital 2.0 channel signals are input, the surround modes in ( ) can be selected, too.

\* When PCM (2 channel stereo) signals are input in the auto or PCM mode, the following modes can be selected.

↳ DOLBY PRO LOGIC II MOVIE ↔ DOLBY PRO LOGIC II MUSIC ↔ DOLBY PRO LOGIC ↔ DOLBY VIRTUAL ↔ DTS NEO MOVIE ↔ DTS NEO MUSIC  
↳ MATRIX ↔ GAME ↔ ARENA 2 ↔ ARENA 1 ↔ CLUB 2 ↔ CLUB 1 ↔ CHURCH ↔ STADIUM ↔ HALL 2 ↔ HALL 1 ↔ MOVIE ↔ THEATER

- When the analog input is selected as signal input and analog stereo signals are input, you can select the same surround modes as those listed for the PCM input.
- However, when DTS or MPEG signals are input in the following decoding modes, the corresponding surround mode will be automatically selected regardless of using the MULTI CONTROL knob or DSP MODE button:
  - \* When DTS signals are input in the auto or DTS mode, the corresponding DTS mode will be selected.
  - \* When MPEG signals are input in the auto or MPEG mode, MPEG mode will be selected.

■ Notes:

- When the selected decoding mode is not matched to the input signal format, the indicator of the signal being input flickers, meaning the required process cannot be performed and no sound is heard. Therefore, be sure to select the required decoding mode and the available surround mode according to the input signal format.
- When the 7.1 CH DIRECT is selected as an input source, the surround mode cannot be selected.
- When the source direct function is activated, the decoding mode and surround mode cannot be selected.



- When playing some multi-channel program sources in the Extra Surround 6.1/7.1 mode.

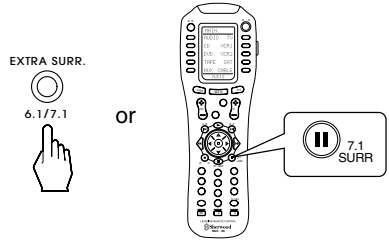

- When the digital signals from the following program sources only are input in the available decoding mode, if these buttons are pressed, the corresponding surround mode will be selected.
  - \* Dolby Digital 5.1-channel sources(including THX Surround EX created using the Dolby Digital Surround EX technology) : EXTRA SURROUND mode,
  - \* DTS 5.1-channel sources : DTS ES MATRIX mode.
- Press the EXTRA SURROUND 6.1/7.1 button on the front panel or the 7.1 CH SURROUND button on the remote control again to cancel the 6.1(or 7.1) surround mode.
- According to whether the surround back speaker is set to “1CH” or “2CH”, the 6.1 or 7.1 mode is selected.
- However, when the surround back speaker is set to “None”, the Extra Surround 6.1/7.1 mode cannot be activated.

- When canceling the surround mode for normal stereo operation.

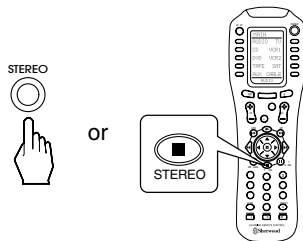

- Then the stereo mode is selected.
- To cancel the stereo mode, select the desired surround mode with using the MULTI CONTROL knob or the DSP MODE button, etc.

### Adjusting each channel level

- If you have performed the CH LEVEL TRIM procedure on the OSD menu, you can skip this procedure. (For details, refer to “SETTING THE CH LEVEL TRIM” on page 49.)

**3** Select the desired channel.

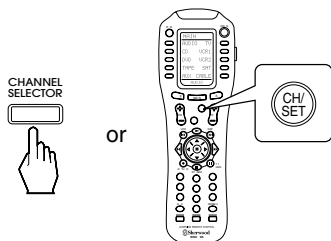

- Each time this button is pressed, the corresponding channel is selected and displayed for 3 seconds as follows:

→ FRONT-L → CENTER(or FRONT-C) → FRONT-R → SURR-R  
 ↳ SUBWOOFER ← SURR-L(←SURR-C) or (← BACK-L ← BACK-R) ←

- Depending on the speaker setting, items set to None or No cannot be selected.

**4** Adjust the level of the selected channel as desired.

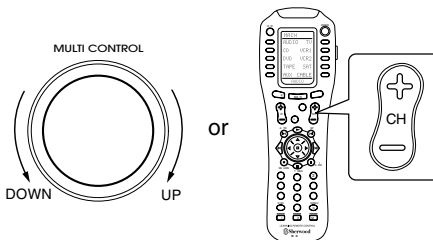

- If the channel display disappears, start from the above step ③ again.

**5** Repeat the above steps ③ and ④ to adjust each channel level until the sound level of each speaker is heard to be equally loud.

### Adjusting each channel level with test tone

- Only when playing a program source in available surround modes except the DOLBY VIRTUAL mode, the volume level of each channel can be adjusted easily with the test tone function.
- Note: When the 7.1 CH DIRECT is selected as an input source, the test tone function does not work.

**6** Enter the test tone mode.

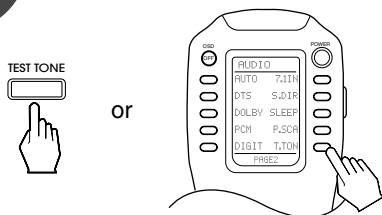

- The test tone will be heard from the speaker of each channel for 2 seconds as follows:
- Front Left → Center → Front Right → Surround Right  
 ↳ Surround Left (← Surround Center) or (← Back Left ← Back Right) ←  
 ↳ SUBwoofer

- Depending on the speaker setting(None or No), the test tone of the corresponding channel is not available.

**7** At each channel, adjust the level as desired until the sound level of each speaker is heard to be equally loud.

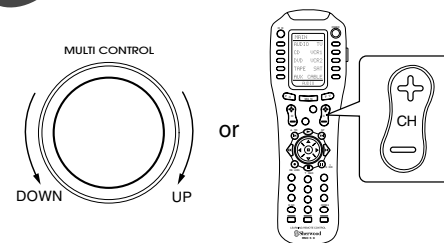

- You can select the desired channel and adjust its level with repeating the steps ③ and ④ in “Adjusting each channel level” procedure.

**8** Cancel the test tone function.

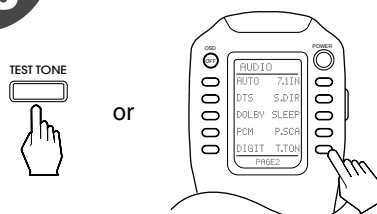

## Downmixing into 2 front channels

- Allows the multi - channel signals encoded in DTS, Dolby Digital or MPEG format to be reproduced through only two front speakers or through headphones.
- When the digital signals from the DTS, Dolby Digital or MPEG program sources are input, press the STEREO button.

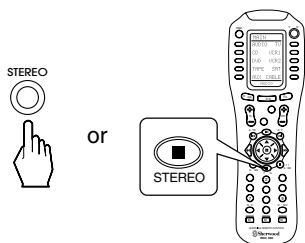

- “DTS”, “MPEG” or “DOLBY DIGITAL” indicator lights up and “2 CH DOWNMIX” is scrolled, meaning it enters the 2-CH downmix mode, and then the discrete multi-channels(except LFE) are mixed down into 2 front channels.

- To cancel the 2 - CH downmix mode, select the desired surround mode with using the MULTI CONTROL knob or the DSP MODE button, etc.
- When the playback of the source on the player is stopped or interrupted, etc, the 2 - CH downmix mode is not canceled even though “DTS”, “DOLBY DIGITAL” or “MPEG” indicator goes off.
- If headphones are plugged in and the SPEAKER A/B button is set to the off mode while the digital signals from the DTS, Dolby Digital or MPEG program sources are being input, it will enter the 2-CH downmix mode automatically and if headphones are unplugged and the SPEAKER A/B button is set to the speaker-on mode while in the 2-CH downmix mode, it will return to the previous mode.

# LISTENING TO RADIO BROADCASTS

## Auto tuning

**1** Select the tuner.

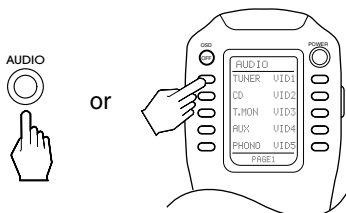

**2** Select the desired band.



- Each time this button is pressed, the band changes as follows :

→ FM Stereo mode → FM Mono mode → AM  
 (“STEREO” lights up) (“STEREO” goes off)

- When FM stereo broadcasts are poor because of weak broadcast signals, select the FM mono mode to reduce the noise, then FM broadcasts are reproduced in monaural sound.
- When pressing the BAND button without selecting the TUNER, the tuner will be selected automatically.

**3** Select the tuning mode.

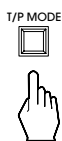

- Each time this button is pressed, the mode changes as follows:

→ Tuning mode : “PRESET” goes off.  
 Preset mode : “PRESET” lights up. ←

**4** Press the TUNING/PRESET UP(▲) or DOWN(▼) button for more than 0.5 second.

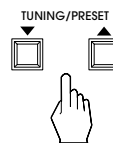

- Then “ AUTO” appears on the display. The tuner will now search until a station of sufficient strength has been found. The display shows the tuned frequency and “TUNED”.
- If the station found is not the desired one, simply repeat this operation.
- Weak stations are skipped during auto tuning.

## Manual tuning

- Manual tuning is useful when you already know the frequency of the desired transmitter.
- Perform the steps ①~③ in “Auto tuning” procedure and press the TUNING/PRESET UP(▲) or DOWN(▼) button repeatedly until the right frequency has been reached.

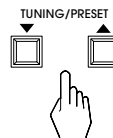

## Presetting radio stations

- You can store up to 30 preferred stations in the memory.

**1** Tune in the desired station with auto or manual tuning.

**2** Press the MEMORY/ENTER button.

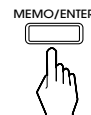

- “MEMO” is flickering for 5 seconds.

**3** Select the desired preset number(1~30) and press the MEMORY/ENTER button.

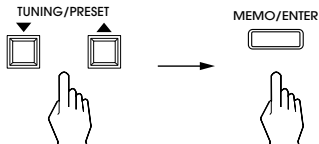

- When using the NUMERIC buttons on the remote control.

Examples)

For “3” : ③

For “15” : ① → ⑤  
within 2 seconds

For “30” : ⑩

- The station has now been stored in the memory.
- When using the NUMERIC buttons, the station is stored automatically without pressing the MEMORY/ ENTER button.
- A stored frequency is erased from the memory by storing another frequency in its place.
- If “MEMO” goes off, start again from the above step ②.

**4** Repeat the above steps ① to ③ to memorize other stations.

**■ MEMORY BACKUP FUNCTION**

The following items, set before the receiver is turned off, are memorized.

- INPUT SELECTOR settings
- Surround mode settings
- Preset stations, etc.

■ Note : If the electricity fails or the AC input cord is disconnected for about 2 weeks, all memorized settings will be lost.

**Tuning to preset stations**

**1** After selecting the tuner as input source, select the preset tuning mode.

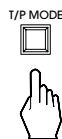

- Then “PRESET” lights up.

**2** Select the desired preset number.

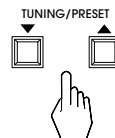

- When using the NUMERIC buttons on the remote control.

Examples)

For “3” : ③

For “15” : ① → ⑤  
within 2 seconds

For “30” : ⑩ (or ③ → ⑩)  
within 2 seconds

- When selecting the desired preset number with the NUMERIC buttons, the desired preset station will be tuned to automatically without selecting the preset tuning mode.

**Scanning preset stations in sequence**



- The receiver will start scanning the stations in the preset sequence and each station is received for 5 seconds.
- At the desired station, press this button again to stop scanning.

# RECORDING

- The analog signals from the 7.1 CH DIRECT inputs as well as the digital signals from the coaxial or optical digital input can be heard but cannot be recorded.
- The volume, tone (bass, treble) settings, etc. have no effect on the recording signals.

## Recording with TAPE MONITOR

- 1** Select the desired input as recording source except TAPE MONITOR.

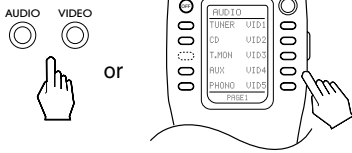

- Be sure that "TAPE MON" goes off.

- 2** Start recording on the component hooked up to TAPE MONITOR.

- 3** Start play on the desired input.

- For tape monitor function, refer to "TAPE MONITOR function" on page 18.

## Dubbing from video components onto VIDEO 1

- 1** Select VIDEO 2, VIDEO 3, VIDEO 4 or VIDEO 5 as a recording source.

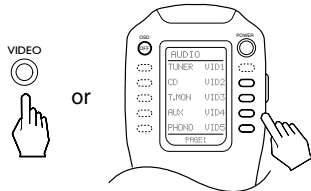

- 2** Start recording on the component hooked up to VIDEO 1.

- 3** Start play on the component hooked up to VIDEO 2, VIDEO 3, VIDEO 4 or VIDEO 5.

- The audio and video signals from the VIDEO 2, VIDEO 3, VIDEO 4 or VIDEO 5 component will be dubbed onto the VIDEO 1 and you can enjoy them on the TV set and from the speakers.

## Dubbing the sound and image signals separately onto VIDEO 1

Example) When dubbing the VIDEO 2 image signal and the CD sound signal separately onto VIDEO 1.

- 1** Select VIDEO 2 as a image recording source.

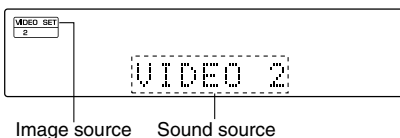
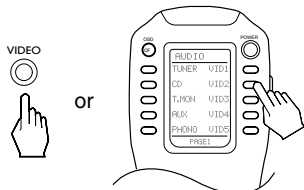

- 2** Select CD as the sound recording source.

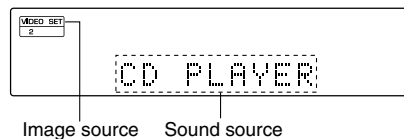
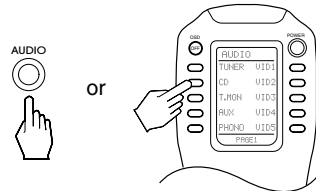

3

Start recording on the component hooked up to the VIDEO 1.

4

Start play on the components hooked up to the VIDEO 2 and the CD respectively.

- The audio signal from the CD and the video signal from the VIDEO 2 component will be dubbed and you can enjoy them on the TV set and from the speakers.

■ Note : Be sure to observe the order of the above steps ① and ②.

## DIGITAL AUDIO RECORDING WITH MD RECORDER

- Only when the OPTICAL DIGITAL OUT of this receiver is connected to the OPTICAL DIGITAL IN of the MD recorder or CD recorder, you can enjoy high-quality sound of digital recording without converting the original signals. Refer to “CONNECTING AUDIO COMPONENTS” and “CONNECTING DIGITAL INs and OUT” on page 5 and 7 and the operating instructions of the MD recorder or CD recorder.

■ Notes:

- Digital recording is available for the digital audio program sources such as CDs, MDs, some DVDs, etc.
- In most DVDs as well as some CDs, etc., digital recording may not be available depending on the signal format.
- There are some restrictions on recording digital signals. When making digital recordings, refer to the operating instructions of your digital recording equipment to know what restrictions are imposed.

1

Select a desired input of CD, TAPE MONITOR and VIDEO 1~VIDEO 5 as a recording source.

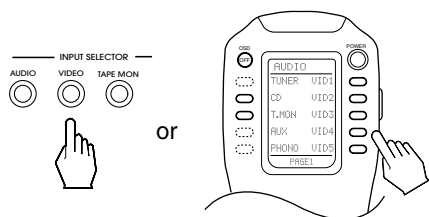

2

For digital recording, select the desired digital input as the recording signal input.

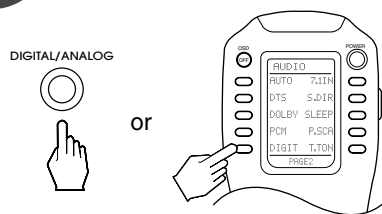

- Each time this button is pressed, the corresponding input is selected as follows:

→ DIGITAL → ANALOG →

■ Note : When the selected digital input is not connected, “DIGITAL” is flickering. There will be no recording as well as no sound.

3

Start recording on the component connected to OPTICAL DIGITAL OUT.

4

Start play on the desired input.

## OTHER FUNCTIONS

### Compressing the dynamic range (Dolby Digital sources only)

- This function compresses the dynamic range of previously specified parts of the Dolby Digital sound track (with extremely high volume) to minimize the difference in volume between the specified and non-specified parts.

This makes it easier to hear all of the sound track when watching movies at night at low levels.

- When the digital signals from the Dolby Digital program source are input.

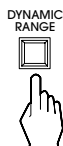

- Each time this button is pressed, the mode changes and disappears in 3 seconds as follows:

DYNAMIC : 0.0 : Off

DYNAMIC : 0.5 : Low compression

DYNAMIC : 1.0 : High compression

- In some Dolby Digital software, this function may not be available.

### Operating the sleep timer

- The sleep timer allows the system to continue to operate for a specified period of time before automatically shutting off.
- To set the receiver to automatically turn off after the specified period of time.

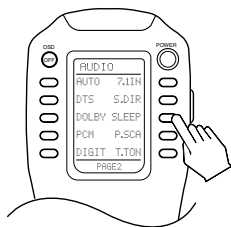

- Each time this button is pressed, the sleep time changes and disappears in 3 seconds as follows:

→ 10 → 20 → 30 → 60 → 90 → OFF

Unit : minutes

- While operating the sleep timer, "SLEEP" lights up.
- When the sleep time is selected, all display panels of Sherwood components connected by the DIGI LINK III are dimly lit.

### Adjusting the brightness of the fluorescent displays

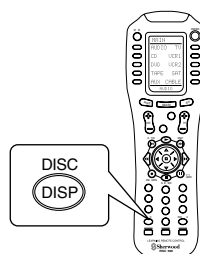

- Each time this button is pressed, the brightness of all fluorescent displays of Sherwood components connected by the DIGI LINK III changes together as follows:

→ ON → dim → OFF

- In the display OFF mode, pressing any button will restore the display ON mode.



### Entering a video label

- This function can be operated only on video input sources such as VIDEO 1~5.

**1** Select the desired video input source to enter its label.

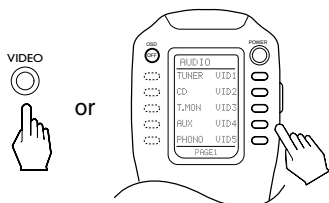

**2** Press the VIDEO LABEL button to enter the video label mode.  
Example) When selecting VIDEO 1.



**3** Select the character on the flickering digit.

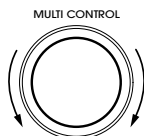

- Each time the MULTI CONTROL knob is rotated, the characters change as follows:

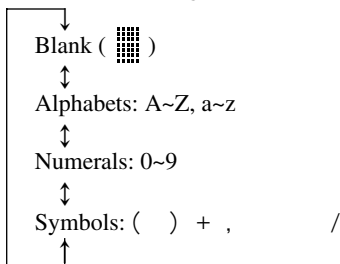

**4** Confirm your selection.



- Then the next digit will flicker.

**5** Repeat the above steps ③ and ④ to enter the desired characters on the rest of the digits.

- On up to 9 digits, the desired characters can be entered.
- Note: If any button such as “AUDIO”, “VIDEO”, “7.1 CH DIRECT” button, etc. is pressed while entering a video label, the video label mode will be canceled.

**6** Memorize the desired video label.

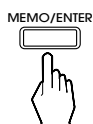

### Correcting or clearing a video label

**1** Select the desired video input source to be rectified or cleared.

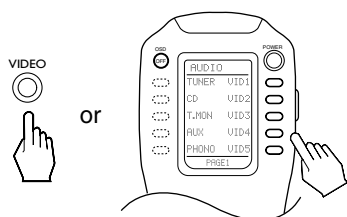

**2** Repeat the steps ②~⑥ in “Entering a video label” procedure.

- To clear a video label, make a blank on each digit and memorize it, then the video label is cleared and its factory video input source will be displayed.
- If the VIDEO LABEL button is pressed for more than 3 seconds, blanks will be made on all the digits at once.

## ROOM 2 SOURCE PLAYBACK

- This function allows enjoying one source in the main room and playing another in a different room at the same time.
- The analog signals from the 7.1 CH DIRECT inputs and TAPE MONITOR INs as well as the digital signals from the coaxial or optical digital input cannot be output from the ROOM 2 OUTs, meaning no playback in a different room.
- When you connect the multi - room adapter to the MULTI - ROOM jack of this unit, you can control this unit with not only the universal remote control unit but also the ROOM 2 remote control unit in a different room, too. (For details, refer to "CONNECTING MULTI - ROOM SYSTEM KIT" on page 8 and "ROOM 2 Remote Controls" on page 17.)

- When using the ROOM 2 remote control unit
- You can use the ROOM 2 function with the ROOM 2 remote control unit more conveniently.

1

Press the ROOM 2 button.

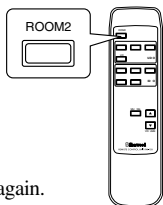

- "R2" is flickering for 3 seconds and the ROOM 2 function is activated.
- To cancel the ROOM 2 function, press it again. Then "R2" goes off.
- In the operating mode, when one of the ROOM 2 INPUT SELECTOR buttons on this remote control is pressed, the ROOM 2 function is automatically activated without pressing the ROOM 2 button and the desired input is selected.

2

Select the desired input as a ROOM 2 source.

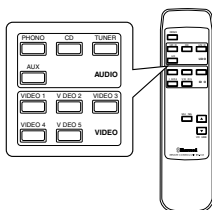

- The selected ROOM 2 source is displayed for 3 seconds as follows: (R2) PHONO, (R2) TUNER, (R2) CD, (R2) AUX, (R2) VIDEO 1~5.
- Only these sources can be played in another room.
- When an audio program source is selected as a ROOM 2 source, the image of the video program source selected previously can be played separately, too. (For details, refer to "SETTING THE ROOM2 FEED SETUP" on page 50.)
- The MUTE and VOLUME UP/DOWN(▲/▼) buttons on this remote control can be available for the ROOM 2 source only.
- Note:
  - When the muting effect for the ROOM 2 source is operating, "R2" is flickering.

3

Start play on the component related to the ROOM 2 source.

■ Notes:

- Even when this unit enters the standby mode, in such a case that "R2" lights up still and the STANDBY button lights up in blue as it does in the operating mode, meaning only the ROOM 2 circuitry operates, the ROOM 2 source can be played independently.
- When the ROOM 2 function is operating in the standby mode, only the ROOM 2 remote control unit is available.
- When you do not use the ROOM 2 function, cancel the ROOM 2 function to save electricity.
- For ROOM 2 volume adjustment, refer to "SETTING THE ROOM 2 FEED SETUP" on page 50.

- When using the universal remote control unit or the buttons on the front panel.

1

Press the ROOM 2 button.

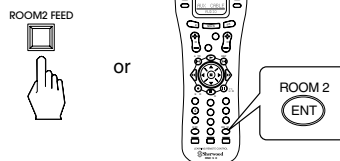

- "R2" flickers for 3 seconds and the ROOM 2 function is activated.
- To cancel the ROOM 2 function, press the button. Then "R2" goes off.
- You can cancel the ROOM 2 function with using these buttons even in the standby mode.

2

Select the desired input as a ROOM 2 source while "R2" is flickering.

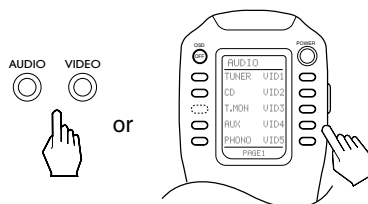

- The selected ROOM 2 source is displayed for 3 seconds.
- Only while "R2" is flickering, the volume level for the ROOM 2 source can be adjusted.
- When "R2" is not flickering and lights up, press the ROOM 2 button briefly twice.

3

Start play on the component related to the ROOM 2 source.

# Using the OSD

This unit incorporates an OSD(On-screen display) function to provide information about basic operation of this unit and to simplify the setup procedures.

The OSD function uses a monitor TV connected to this unit as a display and has two kinds of display modes such as current status display and menu screen.

- Notes:
  - The OSD function is not available via the component video connection.
  - Any on-screen display shown on the monitor TV will not be recorded onto VIDEO 1.

## CURRENT STATUS DISPLAY

This mode shows the status corresponding to each operation.

- The on-screen display will automatically disappear in 5 seconds.
- For examples, there are 2 status displays as follows.
- Note :
  - When watching a movie earnestly, if you want to turn off the current status display function, set the OSD mode to Off.(For details, refer to “When selecting the OSD MODE” on page 44.)

■ When selecting the desired input source.

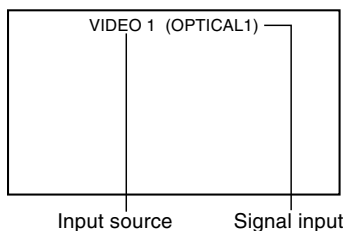

■ When selecting the TEST TONE mode.

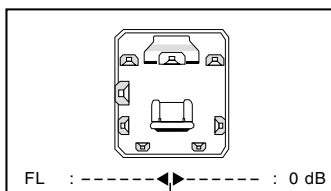

Channel level or overall volume display

- When adjusting each channel level or overall volume, the volume level display will be shown.
- The test tone display will be shown until the test tone mode is canceled.

# OSD Menu Settings

- The OSD menu allows you to perform the setup procedures easily. In most situations, you will only need to set this once during the installation and layout of your home theater, and it rarely needs to be changed later. The OSD menu consists of 6 main menus: power amp assign, speaker setup, function select, surround setup, CH level trim and room 2 feed setup. Some of these menus are divided up into various sub-menus.
- The OSD menu settings are performed easily with the CURSOR control(▲, ▼, ◀, ▶), ON-SCREEN DISPLAY, RETURN and ENTER buttons.
- The “3”, “7”, “8” and “9” of the NUMERIC buttons do also work as the CURSOR control(▲, ▼, ◀, ▶)buttons do. In this case, the “3” button stands for the CURSOR UP(▲) button, the “7” for the CURSOR LEFT(◀), the “8” for the CURSOR DOWN(▼) and the “9” for the CURSOR RIGHT(▶).

1

Turn the menu screen on.

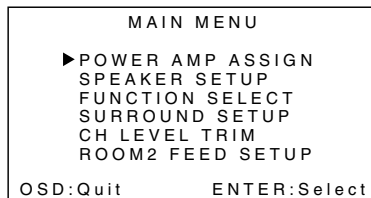
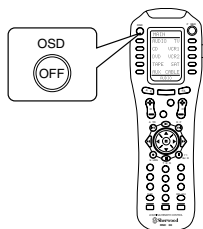

- The main menu will be shown.
- To turn the menu screen off, press this button again.

- In the bottom of the display, “OSD” stands for the ON-SCREEN DISPLAY button, “RETURN” for “RETURN”, “ENTER” for “ENTER”, “▲”, “▼”, “◀” and “▶” for CURSOR UP(▲), DOWN(▼), LEFT(◀) and RIGHT(▶).

**2** Select the desired menu using the CURSOR UP(▲)/DOWN(▼) buttons.

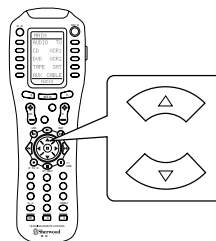

**3** Confirm your selection.

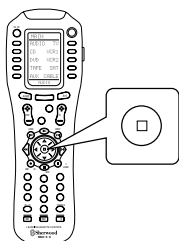

• The selected category or item will provide the needed setting details using the subsequent screens.

■ When selecting the POWER AMP ASSIGN.

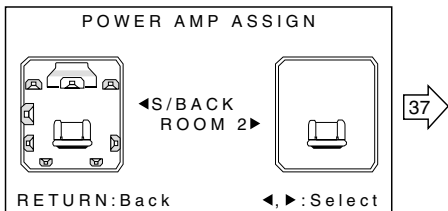

■ When selecting the SPEAKER SETUP.

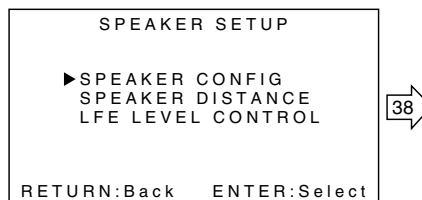

■ When selecting the FUNCTION SELECT.

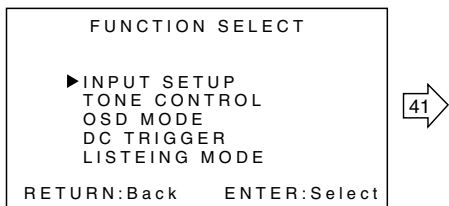

■ When selecting the SURROUND SETUP.

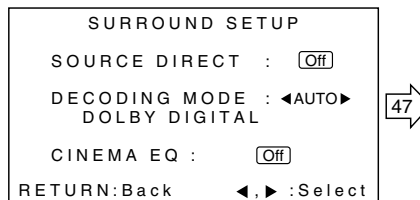

■ When selecting the CH LEVEL TRIM.

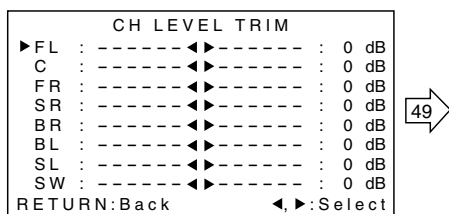

■ When selecting the ROOM2 FEED SETUP.

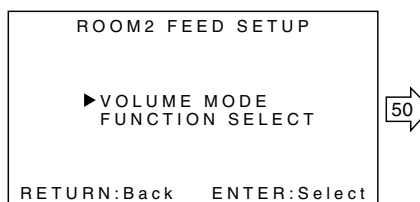

- For the setting details, see page in □.
- Adjust the setting(s) in each setting category to your preference.
- When the RETURN button is pressed on a sub-menu, the previous menu is resumed.

## SETTING THE POWER AMP ASSIGN

- You can assign the power amplifier for the surround back channels to the ROOM 2. In this case, you need not use the power amplifier to drive the speakers additionally in a different room (ROOM 2).

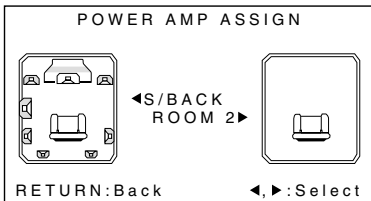

Press the CURSOR LEFT (◀)/RIGHT (▶) buttons to use the power amplifier as desired.

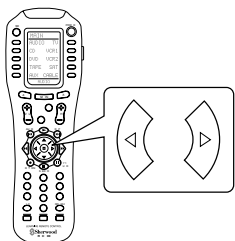

- Each time these buttons are pressed, the power amplifier is assigned as follows :

S /BACK : Select this to use power amplifier

↓ for the surround back channels.

ROOM 2 : Select this to use it for the ROOM 2.

## SETTING THE SPEAKER SETUP

- After you have installed this unit and connected all the components, you first perform the speaker setup settings for the optimum sound acoustics according to your environment and speaker layout.

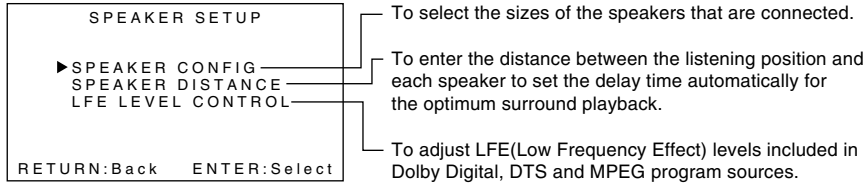

### When selecting the SPEAKER CONFIG

- 1** Press the CURSOR UP(▲)/DOWN(▼) buttons to select the SPEAKER CONFIG, then press the ENTER button.

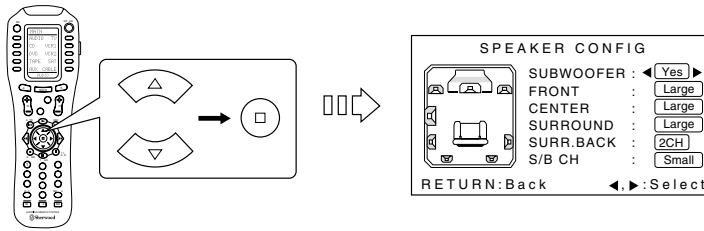

- 2** Press the CURSOR UP(▲)/DOWN(▼) buttons to select the desired speaker.

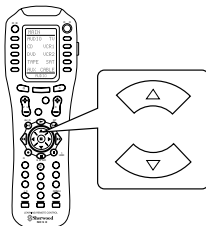

- Each time these buttons are pressed, “◀” and “▶” are moved to the corresponding speaker mode.

- 3** Press the CURSOR LEFT(◀)/RIGHT(▶) buttons to select the desired mode.

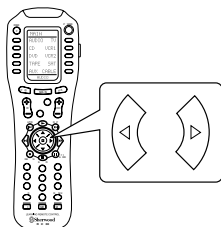

- Depending on your speaker type, you can select one of these following speaker types.
- Yes/No : Select the desired depending on whether a subwoofer is connected or not.
- Large : Select this when connecting speakers that can fully reproduce sounds below 80 Hz.
- Small : Select this when connecting speakers that cannot fully reproduce sounds below 80 Hz. When this is selected, sounds below 80 Hz are sent to the subwoofer.
- None : Select this when no speakers are connected. When this is selected, sounds are sent to the front speakers.
- 2CH/1CH : Select the desired depending on the number of surround back speakers.

■ Notes :

- When “FRONT” is set to “Small”, “SUBWOOFER” is automatically set to “Yes”, and when “SUBWOOFER” is set to “No”, “FRONT” is automatically set to “Large”.
- When “FRONT” is set to “Small”, “CENTER”, “SURROUND” and “S/B CH” cannot be set to “Large”.
- When “SURROUND” is set to “None”, “SURR. BACK” cannot be selected.
- When “CENTER” is set to “None”, “SURROUND” cannot be set to “None” and vice versa.
- When “SURROUND” is set to “Small”, “S/B CH” cannot be set to “Large”.

**4**

Repeat the above steps ② and ③ until the speakers are all set to the desired mode.

**When selecting the SPEAKER DISTANCE**

**1**

Press the CURSOR UP(▲)/DOWN(▼) buttons to select the SPEAKER DISTANCE, then press the ENTER button.

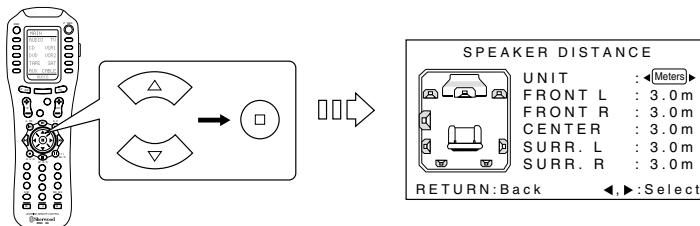

**2**

Press the CURSOR UP(▲)/DOWN(▼) buttons to select the unit.

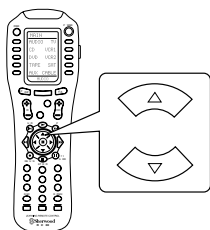

• Then “◀” and “▶” are moved to the unit mode.

**3**

Press the CURSOR LEFT(◀)/RIGHT(▶) buttons to select the desired unit.

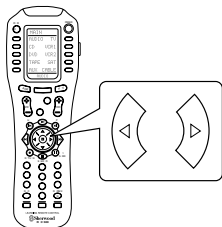

- Each time these buttons are pressed, “Meters” or “Feet” is selected.
- Once a unit is selected, the distances are automatically changed in the selected unit.

**4**

Press the CURSOR UP(▲)/DOWN(▼) buttons to select the desired speaker.

- Then “◀” and “▶” are moved to its distance.
- You cannot select the subwoofer, surround back speakers and the speakers set to “None”.

**5**

Press the CURSOR LEFT(◀)/RIGHT(▶) buttons to enter the distance from the selected speaker to the listening position.

- You can set the distance within the range of 0.3~9 meters in 0.3 meter intervals(or 1~30 feet in 1 feet intervals)

**6**

Repeat the above steps ④ and ⑤ until the distances are all entered.

## When selecting the LFE LEVEL CONTROL

1

Press the CURSOR UP(▲)/DOWN(▼) buttons to select the LFE LEVEL CONTROL, then press the ENTER button.

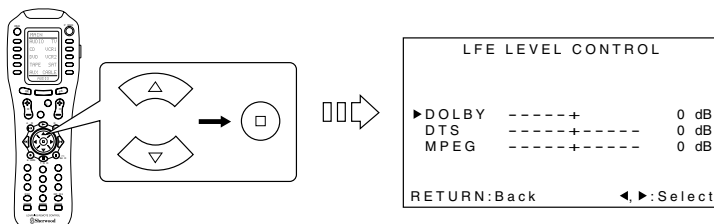

2

Press the CURSOR UP(▲)/DOWN(▼) buttons to select the desired LFE level mode.

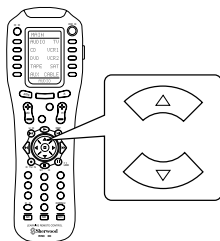

- Each time these buttons are pressed, “▶” is moved to the corresponding LFE level mode.

3

Press the CURSOR LEFT(◀)/RIGHT(▶) buttons to adjust the selected LFE level as desired.

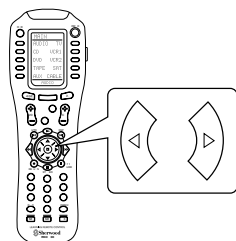

- Each time these buttons are pressed, the LFE level can be adjusted within the range of either -10~0 dB for Dolby Digital program sources or -10~+10 dB for DTS and MPEG program sources.
- In general, we recommend the LFE level for Dolby Digital program sources to be set at 0 dB and +10 dB for DTS program sources. (However, the recommended LFE level for some early DTS program sources is 0 dB.) If the recommended levels seem too high, lower the setting as necessary.

4

Repeat the above steps ② and ③ until each level is adjusted as desired.



## SETTING THE FUNCTION SELECT

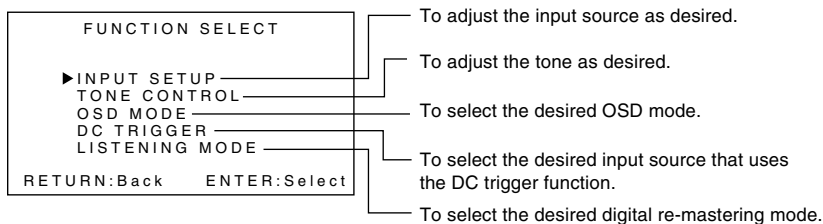

■ Note:

- When the source direct function is selected, the TONE CONTROL cannot be selected.

### When selecting the INPUT SETUP

1

Press the CURSOR UP(▲)/DOWN(▼) buttons to select the INPUT SETUP, then press the ENTER button.

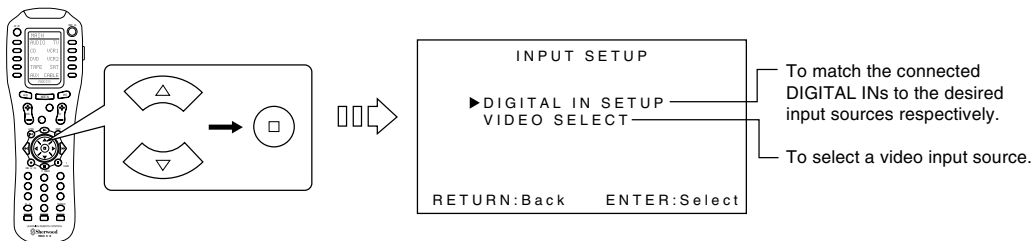

■ When selecting the DIGITAL IN SETUP

- You can match the connected DIGITAL INs to the desired of CD, TAPE MONITOR and VIDEO 1~5. (For details, refer to “CONNECTING DIGITAL INs and OUT” on page 7.)

2

Press the CURSOR UP(▲)/DOWN(▼) buttons to select the DIGITAL IN SETUP, then press the ENTER button.

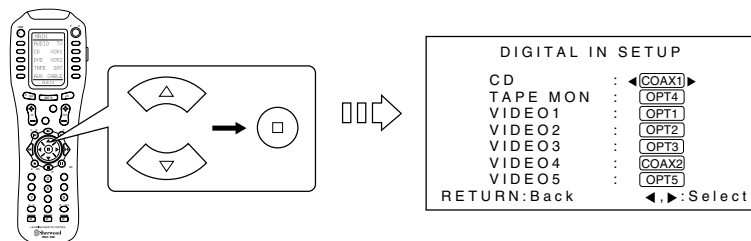

- “OPT 5” means the OPTICAL IN on the front panel.

3

Press the CURSOR UP(▲)/DOWN(▼) buttons to select the desired input source.

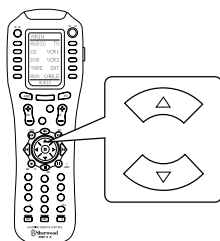

- Each time these buttons are pressed, “◀” and “▶” are moved to the corresponding DIGITAL IN.

4

Press the CURSOR LEFT(◀)/RIGHT(▶) buttons to select the desired DIGITAL IN.

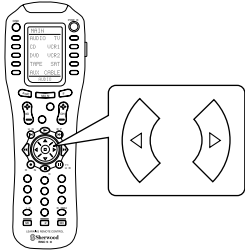

- Each time these buttons are pressed, the DIGITAL INs change.

■ Notes:

- When you select “None” instead of a DIGITAL IN for an input source, the analog input is automatically selected.
- In such a case that a DIGITAL IN is matched to two input sources or more, when these input sources are selected, the digital audio signals can be heard from the same DIGITAL IN.

5

Repeat the above steps ③ and ④ until the connected DIGITAL INs are matched to the desired input sources respectively.

■ When selecting the VIDEO SELECT

- You can also select a video input source on the OSD menu and enjoy it without pressing the VIDEO SELECTOR button(s).

2

Press the CURSOR UP(▲)/DOWN(▼) buttons to select the VIDEO SELECT, then press the ENTER button.

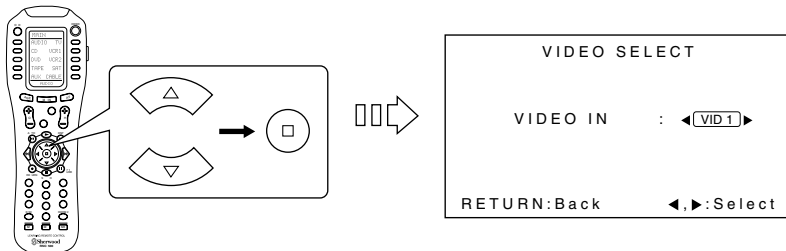

3

Press the CURSOR LEFT(◀)/RIGHT(▶) buttons to select the desired video input source.

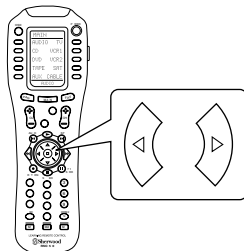

- Each time these buttons are pressed, the video input source changes.
- When you select the VID 6, you can enjoy the image of the 7.1 CH DIRECT source.

## When selecting the TONE CONTROL

1

Press the CURSOR UP(▲)/DOWN(▼) buttons to select the TONE CONTROL, then press the ENTER button.

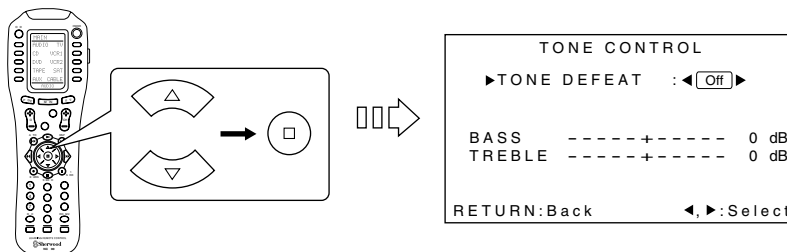

■ Note:

- When the source direct function is activated, the TONE CONTROL cannot be selected.

2

Press the CURSOR LEFT(◀)/RIGHT(▶) buttons to select the desired tone defeat mode.

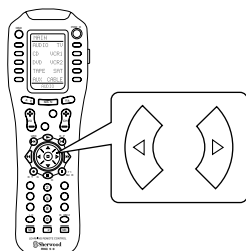

- Each time these buttons are pressed, the tone defeat mode changes as follows:  
 On : Select this when listening to a program source without the tone effect.  
 Off : Select this when adjusting tone for your taste .

■ Note :

- When the tone defeat mode is set to On, the tone (bass and treble) cannot be adjusted.

■ When the tone defeat mode is set to Off to adjust the tone (bass and treble)

1. Press the CURSOR UP(▲)/DOWN(▼) buttons to select the desired tone mode.
  - Each time these buttons are pressed, “▶” is moved to the tone defeat mode or the corresponding tone mode.
2. At the desired tone mode, press the CURSOR LEFT(◀)/RIGHT(▶) buttons to adjust the selected tone as desired.
  - The tone level can be adjusted within the range of -10~+10 dB.
  - In general, we recommend the bass and treble to be adjusted to 0 dB(flat level).
  - Extreme settings at high volume may damage your speakers.
3. To complete tone adjustment, repeat the above steps 1 and 2.

## When selecting the OSD MODE

- When the OSD MODE is set to On, the current status display overlays the program image on the monitor TV and may interfere with your movie enjoyment. In such a case, set the OSD MODE to Off.

1

Press the CURSOR UP(▲)/DOWN(▼) buttons to select the OSD MODE, then press the ENTER button.

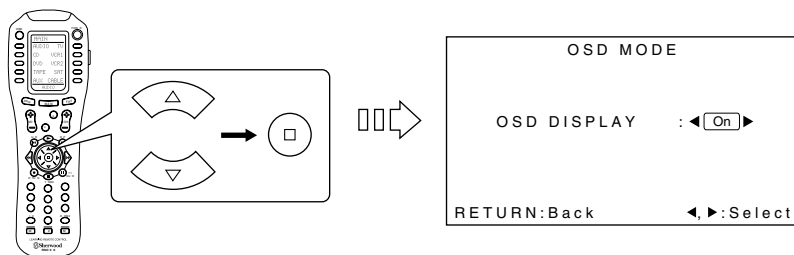

2

Press the CURSOR LEFT(◀)/RIGHT(▶) buttons to select the desired OSD mode.

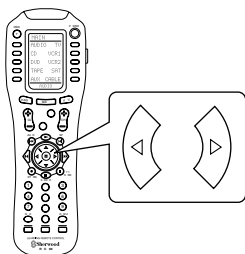

- Each time these buttons are pressed, the OSD mode changes as follows:

On : To turn on the current status display.

↑

Off : To turn off the current status display.

## When selecting the DC TRIGGER

1

Press the CURSOR UP(▲)/DOWN(▼) buttons to select the DC TRIGGER, then press the ENTER button.

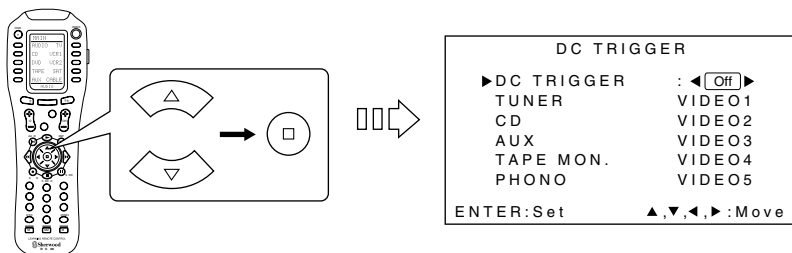

2

Press the CURSOR LEFT(◀)/RIGHT(▶) buttons to select the DC TRIGGER mode as desired.

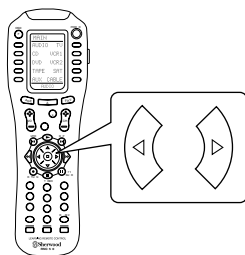

- Each time these buttons are pressed, the DC TRIGGER mode changes as follows:

On : Select this to activate the DC trigger function.



Off : Select this to cancel the DC trigger function.

### ■ When the DC TRIGGER mode is set to On

3

Press the CURSOR UP(▲)/DOWN(▼)/LEFT(◀)/RIGHT(▶) buttons to select the desired input source that uses the DC trigger function, then press the ENTER button.

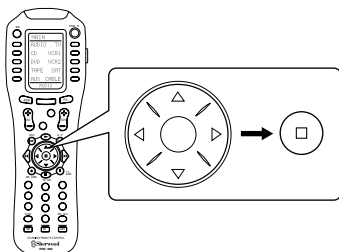

- Each time the CURSOR CONTROL buttons are pressed, “▶” is moved to the corresponding input source. When the ENTER button is pressed at the desired input source, “+” is marked it with.
- When the input sources marked with “+” on this menu are selected with the AUDIO and VIDEO SELECTOR buttons, etc., the DC trigger function is automatically activated. (For details, refer to “CONNECTING DC OUT” on page 7.)
- When the ENTER button is pressed at the input source marked with “+”, “+” is cleared and the DC trigger function is canceled for this input source.
- Repeat this step until the desired input sources are all selected.

## When selecting the LISTENING MODE

1

Press the CURSOR UP(▲)/DOWN(▼) buttons to select the LISTENING MODE, then press the ENTER button.

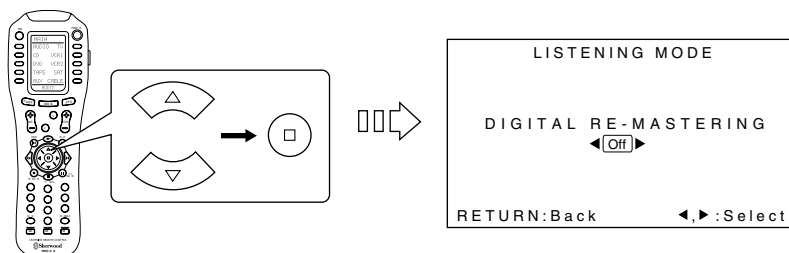

2

Press the CURSOR LEFT(◀)/RIGHT(▶) buttons to select the desired mode.

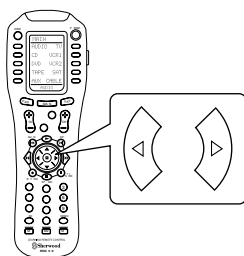

- Each time these buttons are pressed, the digital re-mastering mode changes as follows:  
 On : Select this to process the input signal digitally and to convert its sampling frequency to 192 kHz for an more detailed sound reproduction.  
 ↑  
 ↓  
 Off : Select this to cancel the digital re-mastering function.

### ■ Notes:

- The digital re-mastering function does affect on the front left and right signals only. However, it does not affect on the digital signals that are output from the OPTICAL OUT jack of this unit.
- When analog signals are input in the stereo mode, the 7.1 CH DIRECT is selected as an input source, or the source direct function is selected, the digital re-mastering function is not activated.

## SETTING THE SURROUND SETUP

SURROUND SETUP	
SOURCE DIRECT : <input type="checkbox"/> Off	To select the source direct function for pure sound quality or not.
DECODING MODE : ◀AUTO▶	To select the desired decoding mode.
DOLBY DIGITAL	To select the desired surround mode.
CINEMA EQ : <input type="checkbox"/> Off	To select the cinema EQ function or not.
RETURN:Back	◀, ▶:Select

■ Notes :

- Only when the digital input is selected as signal input, the decoding mode and the surround mode can both be selected as desired.
- When the analog input is selected, only the surround mode can be selected as desired.

**1**

Press the CURSOR UP(▲)/DOWN(▼) buttons to select the desired item.

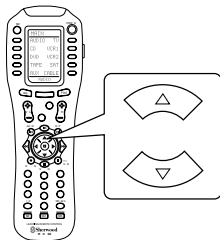

- Each time these buttons are pressed, “◀” and “▶” are moved to the corresponding mode.

**2**

Press the CURSOR LEFT(◀)/RIGHT(▶) buttons to select the desired mode.

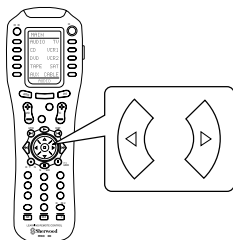

- Each time these buttons are pressed, the modes change as follows according to the selected item :

### When selecting the SOURCE DIRECT

- Only when playing program sources in analog stereo or digital 2 ch PCM format, the SOURCE DIRECT can be selected.
- On : Select this to achieve the pure sound quality.
- ↑ When this is selected, the stereo mode is automatically selected and the pure sound that bypasses the tone circuitry will be heard.
- Off : Select this to cancel the source direct function.

■ Notes :

- When the SOURCE DIRECT is set to On, DECODING MODE, surround mode and CINEMA EQ cannot be selected.
- When you select the 7.1 CH DIRECT as input source or the digital signals from DTS, Dolby Digital or MPEG sources, etc. are input, the source direct function is automatically canceled.

### When selecting the CINEMA EQ

- When 96 kHz PCM(2 channel stereo) signals are input or the source direct function is selected, the cinema EQ function can not be selected.
- On : Select this to compensate for edgy or shrill movie sound tracks.
- ↑
- Off : Select this to cancel the cinema EQ function.

## When selecting the DECODING MODE

- Depending on the input digital signal format, you can select the desired decoding mode.
  - Auto : Select this for automatic detection of a digital input signal format.
    - The input digital signal format (DTS, Dolby Digital, MPEG or PCM(2 channel stereo), etc.) used by the selected digital input source is detected automatically to perform the necessary decoding process for optimum surround modes.
  - Dolby Digital : Select this for Dolby Digital signal processing. The decoding process is performed only when Dolby Digital signals are input.
  - DTS : Select this for DTS signal processing. The decoding process is performed only when DTS signals are input.
  - MPEG : Select this for MPEG signal processing. The decoding process is performed only when MPEG signals are input.
  - PCM : Select this for PCM signal processing. The decoding process is performed only when PCM signals are input.

### ■ Notes :

- Surround sound effect will not work properly if the signal passes through a graphic equalizer. Please refer to your equalizer operating instructions for guidance on switching off(or defeating) the equalizer.
- Only when the digital input is selected as signal input for the input sources except PHONO, TUNER and AUX, the decoding mode can be selected.
- Noise may be generated at the beginning of playback and while searching during DTS playback in the auto mode. In this case, try playing in the DTS mode.

## When selecting the surround mode

- Depending on the input signal format and the selected decoding mode, you can select the desired surround mode as follows:
  - \* When Dolby Digital signals are input in the auto or Dolby Digital mode, the following modes can be selected.

↳ DOLBY DIGITAL (↔ DOLBY PRO LOGIC II MOVIE ↔ DOLBY PRO LOGIC II MUSIC ↔ DOLBY PRO LOGIC) ↔ DOLBY VIRTUAL ↵

Only when Dolby Digital 2.0 channel signals are input, the surround modes in ( ) can be selected, too.

- \* When PCM(2 channel stereo) signals are input in the auto or PCM mode, the following modes can be selected.

↳ DOLBY PRO LOGIC II MOVIE ↔ DOLBY PRO LOGIC II MUSIC ↔ DOLBY PRO LOGIC ↔ DOLBY VIRTUAL ↔ DTS NEO MOVIE ↔ DTS NEO MUSIC ↵  
↳ MATRIX ↔ GAME ↔ ARENA 2 ↔ ARENA 1 ↔ CLUB 2 ↔ CLUB 1 ↔ CHURCH ↔ STADIUM ↔ HALL 2 ↔ HALL 1 ↔ MOVIE ↔ THEATER ↵

- When the analog input is selected as signal input and analog stereo signals are input, you can select the desired of these above surround modes, too.
- However, when DTS or MPEG signals are input in the following decoding modes, the corresponding surround mode will be automatically selected:
  - \* When DTS signals are input in the auto or DTS mode, the corresponding DTS mode will be selected.
  - \* When MPEG signals are input in the auto or MPEG mode, MPEG mode will be selected.

### ■ Notes :

- When the selected decoding mode is not matched to the input signal format, the indicator of the signal being input is flickering, meaning the required process cannot be performed and no sound is heard. Therefore, be sure to select the required decoding mode and the available surround mode according to the input signal format.
- When the 7.1 CH DIRECT is selected as an input source, the surround mode cannot be selected.

### ■ To play some multi-channel program sources in the Extra Surround 6.1/7.1 mode,

- When the digital signals from the following program sources only are input in the available decoding mode, press the EXTRA SURROUND 6.1/7.1 button on the front panel or the 7.1 CH SURROUND button on the remote control, then the corresponding surround mode will be selected.
  - \* Dolby Digital 5.1-channel sources(including THX Surround EX created using the Dolby Digital Surround EX technology) : EXTRA SURROUND mode,
  - \* DTS 5.1-channel sources : DTS ES MATRIX mode.
- Press the EXTRA SURROUND 6.1/7.1 button or the 7.1 CH SURROUND button again to cancel the 6.1(or 7.1) surround mode.
- According to whether the surround back speaker is set to "1 CH" or "2 CH", the 6.1 or 7.1 mode is selected.
- However, when the surround back speaker is set to "None", the Extra Surround 6.1/7.1 mode cannot be activated.



## SETTING THE CH LEVEL TRIM

CH LEVEL TRIM			
▶FL	: -----▶	: 0 dB	
C	: -----▶	: 0 dB	
FR	: -----▶	: 0 dB	
SR	: -----▶	: 0 dB	
BR	: -----▶	: 0 dB	
BL	: -----▶	: 0 dB	
SL	: -----▶	: 0 dB	
SW	: -----▶	: 0 dB	
RETURN: Back		◀, ▶: Select	

1

Press the CURSOR UP(▲)/DOWN(▼) buttons to select the desired channel.

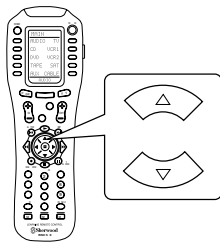

- Each time these buttons are pressed, “▶” is moved to the corresponding channel.

■ Note :

- Depending on the speaker settings such as “None” and “No”, center, surround, surround back or subwoofer channel will not be selected.

2

Press the CURSOR LEFT(◀)/RIGHT(▶) buttons to adjust the level of the selected channel as desired.

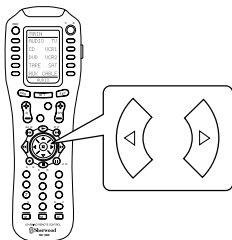

- Each time these buttons are pressed, the channel level can be adjusted within the range of -15~+15 dB.

3

Repeat the above steps ① and ② to adjust each channel level until the sound level of each speaker is heard to be equally loud.

## SETTING THE ROOM2 FEED SETUP

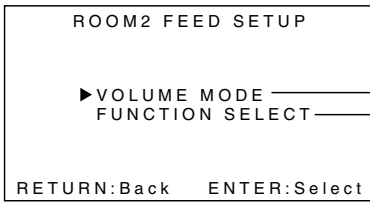

- ▶ VOLUME MODE — To select the desired volume mode.
- FUNCTION SELECT — To select the desired ROOM 2 source.

- The ROOM 2 function allows enjoying one source in the main room while playing another in a different room at the same time.
- The analog signals from the 7.1 CH DIRECT inputs and TAPE MONITOR INs as well as the digital signals from the coaxial or optical digital input cannot be output from the ROOM 2 OUTs.

### When selecting the VOLUME MODE

1

Press the CURSOR UP(▲)/DOWN(▼) buttons to select the VOLUME MODE, then press the ENTER button.

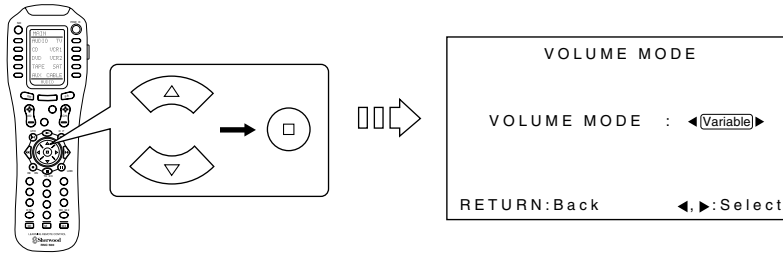

2

Press the CURSOR LEFT(◀)/RIGHT(▶) buttons to select the desired volume mode for the ROOM 2 source.

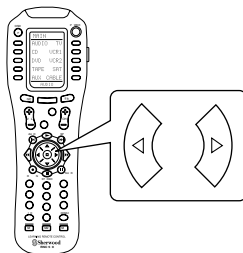

- Each time these buttons are pressed, the volume mode changes as follows:
  - Variable : Select this when a power amplifier is connected to the ROOM 2(audio) OUTs for ROOM 2 source playback. You can adjust the ROOM 2 volume level with the MASTER VOLUME CONTROL knob of this receiver or the VOLUME UP/DOWN buttons on the remote control.
  - Fixed : Select this when an integrated amplifier, etc. is connected to the ROOM 2(audio) OUTs. You can adjust the ROOM 2 volume level on the connected integrated amplifier, etc.

■ Notes :

- When you assign the power amplifier for the surround back channels to the ROOM 2, the volume mode is automatically set to Variable.
- In case that an integrated amplifier, etc. is connected to the ROOM 2(audio) OUTs and the volume mode is set to Variable, if the ROOM 2 volume level is adjusted to high level on both this receiver and the connected amplifier, the ROOM 2 speaker and the connected amplifier may be damaged. Therefore, be sure to set the volume mode to Fixed for safe operation when using amplifier or receiver with its own volume control for ROOM 2.
- When selecting the Fixed mode, first adjust the volume level as desired in the Variable mode and select the Fixed mode. Then the volume level will be fixed to the adjusted level.

### When selecting the FUNCTION SELECT for ROOM 2

- 1** Press the CURSOR UP(▲)/DOWN(▼) buttons to select the FUNCTION SELECT for ROOM 2 source, then press the ENTER button.

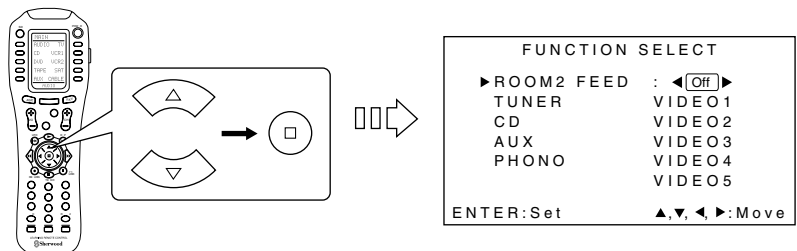

- 2** Press the CURSOR LEFT(◀)/RIGHT(▶) buttons to select the ROOM 2 FEED mode as desired.

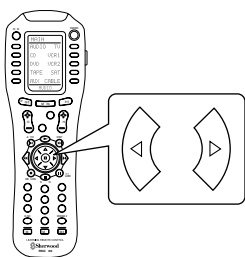

- Each time these buttons are pressed, the ROOM 2 FEED mode is changed to “On” or “Off”.
- When the ROOM 2 FEED mode is set to “Off”, the ROOM 2 source cannot be selected.
- When you do not use the ROOM 2 function, set the ROOM 2 FEED mode to Off to save electricity.

■ When the ROOM 2 FEED mode is set to On

- 3** Press the CURSOR UP(▲)/DOWN(▼)/LEFT(◀)/RIGHT(▶) buttons to select the desired ROOM 2 source, then press the ENTER button.

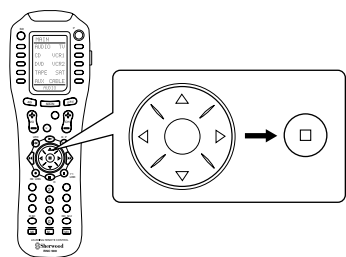

- Each time the CURSOR CONTROL buttons are pressed, “+” is moved to the corresponding input source.
- When the audio input source is selected, a video input source can be marked with “+”, too. It means that the image of the video input source selected previously can be played separately, too.

# Troubleshooting Guide

If a fault occurs, run through the table below before taking your unit for repair.

If the fault persists, attempt to solve it by switching the unit off and on again. If this fails to resolve the situation, consult your dealer. Under no circumstances should you repair the unit yourself as this could invalidate the warranty!

PROBLEM	POSSIBLE CAUSE	REMEDY
No power	<ul style="list-style-type: none"> <li>The AC input cord is disconnected.</li> <li>Poor connection at AC wall outlet or the outlet is dead or off.</li> </ul>	<ul style="list-style-type: none"> <li>Connect cord securely.</li> <li>Check the outlet using a lamp or another appliance.</li> </ul>
No sound	<ul style="list-style-type: none"> <li>The speaker wires are disconnected.</li> <li>The master volume is adjusted too low.</li> <li>The MUTE button is pressed to ON.</li> <li>The selected decoding mode is not matched to the input signal format.</li> <li>Incorrect selection of input source.</li> <li>Incorrect connections between the components.</li> </ul>	<ul style="list-style-type: none"> <li>Check the speaker connections.</li> <li>Adjust the master volume.</li> <li>Press the MUTE button to cancel the muting effect.</li> <li>Select the available decoding mode.</li> <li>Select the desired input source correctly.</li> <li>Make connections correctly.</li> </ul>
No sound from the surround speakers	<ul style="list-style-type: none"> <li>Surround mode is switched off(normal stereo mode).</li> <li>Master volume and surround level are too low.</li> <li>Monaural source is used.</li> <li>Surround speaker setting is "None".</li> </ul>	<ul style="list-style-type: none"> <li>Select a surround mode.</li> <li>Adjust master volume and surround level.</li> <li>Select a stereo or surround source.</li> <li>Select the desired surround speaker setting.</li> </ul>
No sound from the (front) center speaker	<ul style="list-style-type: none"> <li>Dolby Virtual, normal stereo mode, etc is selected.</li> <li>(Front) center speaker setting is "None".</li> <li>Master volume and center level are too low.</li> </ul>	<ul style="list-style-type: none"> <li>Select the desired surround mode.</li> <li>Select the desired (front) center speaker setting.</li> <li>Adjust master volume and center level.</li> </ul>
No sound from the surround back speakers	<ul style="list-style-type: none"> <li>The input signal format or the current surround mode cannot support the 7.1(or 6.1) surround.</li> <li>The power amplifier for the surround back channels is assigned to the ROOM 2.</li> <li>Master volume and surround back level are too low.</li> <li>Surround back speaker setting is "None".</li> </ul>	<ul style="list-style-type: none"> <li>Under the proper situations, perform the 7.1(or 6.1) surround playback.(For details, refer to "ENJOYING SURROUND SOUND" on page 24.)</li> <li>Assign the power amplifier to the surround back channels.(For details, refer to "SETTING THE POWER AMP ASSIGN" on page 37.)</li> <li>Adjust master volume and surround back level.</li> <li>Select the desired surround back speaker setting.</li> </ul>
Stations cannot be received	<ul style="list-style-type: none"> <li>No antenna is connected.</li> <li>The desired station frequency is not tuned in.</li> <li>Antenna is in wrong position.</li> </ul>	<ul style="list-style-type: none"> <li>Connect an antenna.</li> <li>Tune in the desired station frequency.</li> <li>Move antenna and retry tuning.</li> </ul>
Preset stations cannot be received	<ul style="list-style-type: none"> <li>An incorrect station frequency has been memorized.</li> <li>The memorized stations are cleared.</li> </ul>	<ul style="list-style-type: none"> <li>Memorize the correct station frequency.</li> <li>Memorize the stations again.</li> </ul>
Poor FM reception	<ul style="list-style-type: none"> <li>No antenna is connected.</li> <li>The antenna is not positioned for the best reception.</li> </ul>	<ul style="list-style-type: none"> <li>Connect an antenna.</li> <li>Change the position of the antenna.</li> </ul>
Continuous hissing noise during FM reception, especially when a stereo broadcast is received.	<ul style="list-style-type: none"> <li>Weak signals.</li> </ul>	<ul style="list-style-type: none"> <li>Change the position of the antenna.</li> <li>Install an outdoor FM antenna.</li> </ul>
Continuous or intermittent hissing noise during AM reception, especially at night.	<ul style="list-style-type: none"> <li>Noise is caused by motors, fluorescent lamps or lightning, etc.</li> </ul>	<ul style="list-style-type: none"> <li>Keep the receiver away from noise sources.</li> <li>Install an outdoor AM antenna.</li> </ul>
Remote control unit does not operate.	<ul style="list-style-type: none"> <li>Batteries are not loaded or exhausted.</li> <li>The remote sensor is obstructed.</li> </ul>	<ul style="list-style-type: none"> <li>Replace the batteries.</li> <li>Remove the obstacle.</li> </ul>
Other Sherwood components do not react to remote control commands.	<ul style="list-style-type: none"> <li>DIGI LINK connections are not made properly.</li> </ul>	<ul style="list-style-type: none"> <li>Make proper DIGI LINK connections.</li> </ul>
A video label cannot be displayed.	<ul style="list-style-type: none"> <li>Malfunction due to external influences such as static electricity, etc.</li> </ul>	<ul style="list-style-type: none"> <li>Clear it using "To clear a video label". (Refer to "Correcting or clearing a video label" on page 33)</li> </ul>
OSD function is not available.	<ul style="list-style-type: none"> <li>Video connections between this unit and the monitor TV are not made correctly.</li> </ul>	<ul style="list-style-type: none"> <li>Make proper video connections.</li> </ul>

# Specifications

## ■ AMPLIFIER SECTION

• Power output, stereo mode, 8 Ω, THD 0.05%, 20 Hz~20 kHz	2 × 120 W
• Total harmonic distortion, 8 Ω, 120 W, 1 kHz	0.05 %
• Intermodulation distortion	
60 Hz : 7 kHz = 4 : 1 SMPTE, 8 Ω, 120 W	0.09 %
• Input sensitivity/impedance	
Phono (MM)	2.5 mV/47 kΩ
Line (CD, TAPE, VIDEO)	200 mV/47 kΩ
• Signal to noise ratio, IHF "A" weighted	
Phono (MM)	72 dB
Line (CD, TAPE, VIDEO)	100 dB
• Frequency response	
Phono (MM), RIAA, 30~20,000Hz	±1.0 dB
LINE (CD, TAPE, VIDEO), 10~100,000 Hz	+0, -3 dB
• Output level	
TAPE REC, 1 kΩ	180 mV
PRE OUT(Front, Center, Surround, Surround back, Subwoofer), 1 kΩ	1.0 V
• Bass/Treble control, 100 Hz/10 kHz	±10 dB
• Surround mode, only channel driven	
Front power output, 8 Ω, 1 kHz, THD 0.7 %	140 W+140 W
Center power output, 8 Ω, 1 kHz, THD 0.7 %	140 W
Surround power output, 8 Ω, 1 kHz, THD 0.7 %	140 W+140 W
Surround back/ROOM 2 power output, 8 Ω, 1 kHz, THD 0.7 %	140 W+140 W

## ■ DIGITAL AUDIO SECTION

• Sampling frequency	32, 44.1, 48, 96, 192 kHz
• Digital input level	
Coaxial, 75 Ω	0.5 Vp-p
Optical, 660 nm	-15~-21 dBm

## ■ VIDEO SECTION

• Video format	NTSC
• Input sensitivity(=Output level), 75 Ω	
Video(Composite (normal))	1 Vp-p
S-Video(luminance signal)	1 Vp-p
(chrominance signal)	0.286 Vp-p
Component video(R-Y signal)	0.5 Vp-p
(B-Y signal)	0.5 Vp-p
(Y signal)	1.0 Vp-p

## ■ FM TUNER SECTION

• Tuning frequency range	87.5~108 MHz
• Usable sensitivity, THD 3 %, S/N 30 dB	17.2 dBf
• 50 dB quieting sensitivity, mono/stereo	25.2/43.2 dBf
• Signal to noise ratio, 65 dBf, mono/stereo	72/68 dB
• Total harmonic distortion, 65 dBf, 1 kHz, mono/stereo	0.2/0.3 %
• Frequency response, 20 Hz~15 kHz	±1.5 dB
• Stereo separation, 1 kHz	45 dB
• Capture ratio	3.0 dB
• IF rejection ratio	120 dB

## ■ AM TUNER SECTION

• Tuning frequency range	520~1710 kHz
• Usable sensitivity	12.5 mV
• Signal to noise ratio	51dB
• Selectivity	30 dB

## ■ GENERAL

• Power supply	AC 120 V, 60 Hz
• Power consumption	4.3 A
• Switched AC outlets	TOTAL 1A, 100 W max.
• Dimensions(W × H × D)	440 × 166 × 380 mm(17-3/8 × 6-1/2 × 15 inches)
• Weight(Net)	18.5 kg(40.8 lbs)

Note: Design and specifications are subject to change without notice for improvements.

O P E R A T I N G I N S T R U C T I O N S



**R-963**

**AUDIO/VIDEO SURROUND RECEIVER**